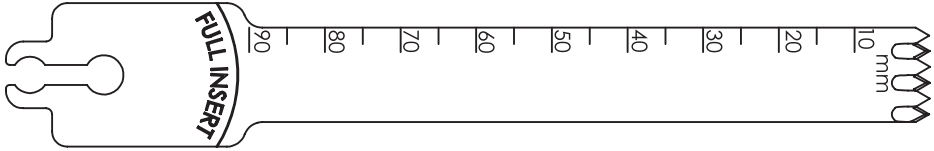
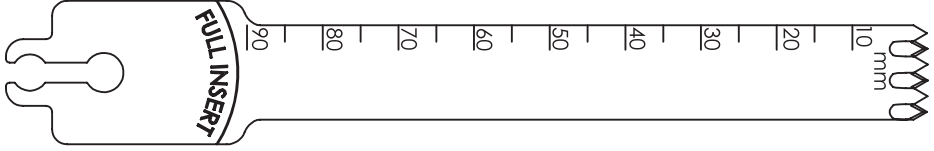
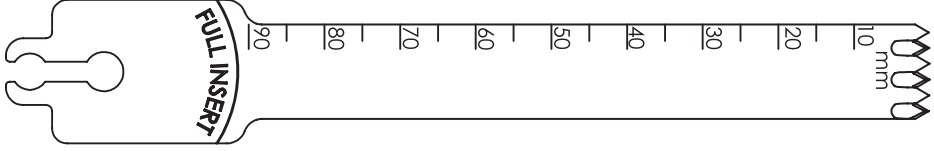
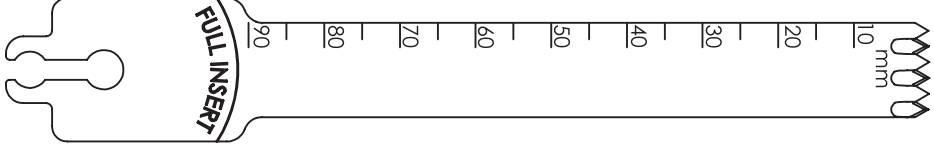

BUSA® Large Bone Saw Blades

Sagittal/Oscillating BR2000™ Proprietary (BR1 Series - Stryker®)

Compatible with Stryker® Sagittal Saw Systems: 8, 7, 6, 5, 4, 2000 & EHD

Stryker®					
Order Number	Unit	Length	Width	Material Thickness	Cut Thickness
BR1-1290-35	mm	90	12.5	0.89	0.89
	in	3.54	0.49	0.035	0.035
Replaces Stryker® 6113-089-090, 6113-89-090, 2108-152-006					
					
Aggressive Cut Diamond Cut No Tooth Offset					
BR1-1290-39	mm	90	12.5	0.99	0.99
	in	3.54	0.49	0.039	0.039
Replaces Stryker® 6113-097-090					
					
Aggressive Cut Diamond Cut No Tooth Offset					
BR1-1290-47	mm	90	12.5	1.19	1.19
	in	3.54	0.49	0.047	0.047
Replaces Stryker® 6113-119-090, 2108-352-000, 2108-352					
					
Aggressive Cut Diamond Cut No Tooth Offset					
BR1-1290-50	mm	90	12.5	1.27	1.27
	in	3.54	0.49	0.050	0.050
Replaces Stryker® 6113-127-090, 2108-356-000, 2108-356					
					
Aggressive Cut Diamond Cut No Tooth Offset					

STRYKER® | Compatible with Stryker® Sagittal Saw Systems: 8, 7, 6, 5, 4, 2000 & EHD



BUSA® Large Bone Saw Blades

Sagittal/Oscillating BR2000™ Proprietary (BR1 Series - Stryker®)

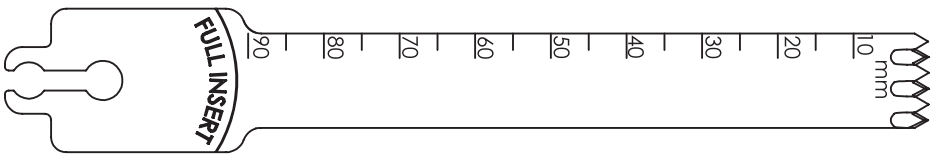
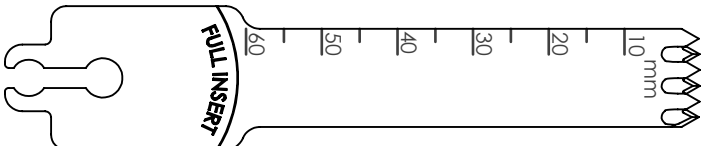

STRYKER® | Compatible with Stryker® Sagittal Saw Systems: 8, 7, 6, 5, 4, 2000 & EHD

Compatible with Stryker® Sagittal Saw Systems: 8, 7, 6, 5, 4, 2000 & EHD

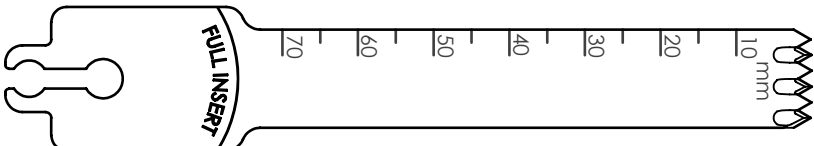
Stryker®					
Order Number	Unit	Length	Width	Material Thickness	Cut Thickness
BR1-1290-54	mm	90	12.5	1.37	1.37
	in	3.54	0.49	0.054	0.054
Replaces Stryker® 6113-137-090					
					
Aggressive Cut Diamond Cut No Tooth Offset					
BR1-1360-50	mm	60	13	1.27	1.27
	in	2.36	0.51	0.050	0.050
Replaces Stryker® 6113-127-060					
					
Aggressive Cut Diamond Cut No Tooth Offset					
BR1-1370-50F	mm	70	13	1.27	1.27
	in	2.76	0.51	0.050	0.050
Replaces Stryker® 6213-127-070					
					
Aggressive Cut Diamond Cut No Tooth Offset					
BR1-1375-50	mm	75	13	1.27	1.27
	in	2.95	0.51	0.050	0.050
Replaces Stryker® 6113-127-075					
					
Aggressive Cut Diamond Cut No Tooth Offset					

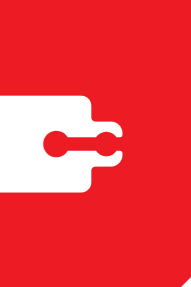

BUSA® Large Bone Saw Blades

Sagittal/Oscillating BR2000™ Proprietary (BR1 Series - Stryker®)

Compatible with Stryker® Sagittal Saw Systems: 8, 7, 6, 5, 4, 2000 & EHD

Stryker®					
Order Number	Unit	Length	Width	Material Thickness	Cut Thickness
BR1-1390-42	mm	90	13	1.07	1.07
	in	3.54	0.51	0.042	0.042
Replaces Stryker® 6113-107-090					
					Aggressive Cut Diamond Cut No Tooth Offset
BR1-1875-35	mm	75	18	0.89	0.89
	in	2.95	0.71	0.035	0.035
Replaces Stryker® 6118-089-075					
					Aggressive Cut Diamond Cut No Tooth Offset
BR1-1875-50	mm	75	18	1.27	1.27
	in	2.95	0.71	0.050	0.050
Replaces Stryker® 6118-127-075					
					Aggressive Cut Diamond Cut No Tooth Offset
BR1-1990-35	mm	90	19	0.89	0.89
	in	3.54	0.75	0.035	0.035
Replaces Stryker® 6118-089-090, 2108-109-001					
					Aggressive Cut Diamond Cut No Tooth Offset

Compatible with Stryker® Sagittal Saw Systems: 8, 7, 6, 5, 4, 2000 & EHD

STRYKER®

BUSA® Large Bone Saw Blades

Sagittal/Oscillating BR2000™ Proprietary (BR1 Series - Stryker®)



STRYKER® | Compatible with Stryker® Sagittal Saw Systems: 8, 7, 6, 5, 4, 2000 & EHD

Compatible with Stryker® Sagittal Saw Systems: 8, 7, 6, 5, 4, 2000 & EHD

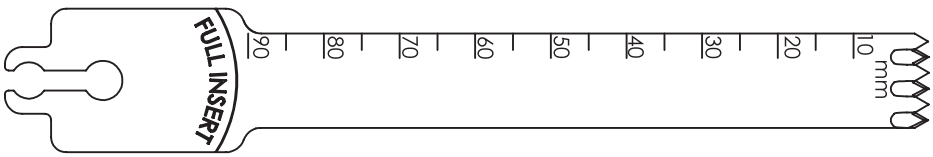
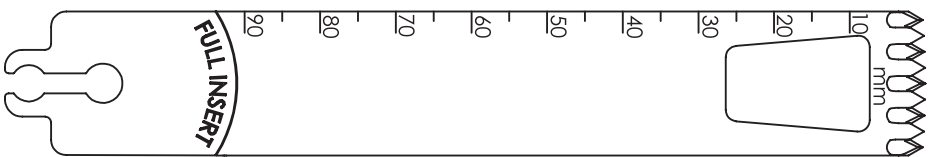
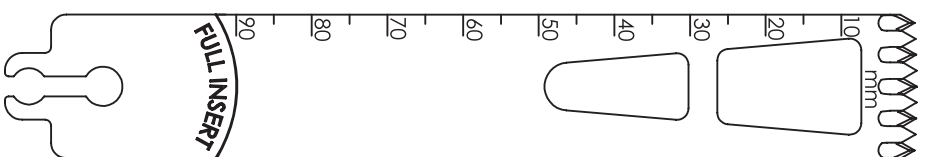
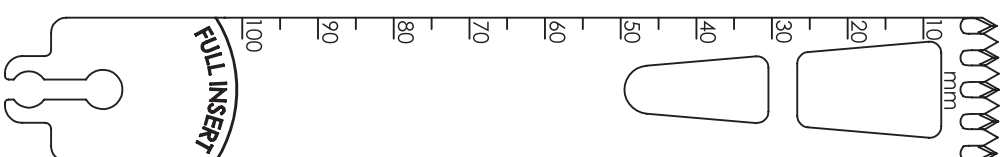
Stryker®					
Order Number	Unit	Length	Width	Material Thickness	Cut Thickness
BR1-1290-54	mm	90	12.5	1.37	1.37
	in	3.54	0.49	0.054	0.054
Replaces Stryker® 6113-137-090					
					
Aggressive Cut Diamond Cut No Tooth Offset					
BR1-1990-39	mm	90	19	0.99	0.99
	in	3.54	0.75	0.039	0.039
Replaces Stryker® 6118-097-090					
					
Aggressive Cut Diamond Cut No Tooth Offset					
BR1-1990-47	mm	90	19	1.19	1.19
	in	3.54	0.75	0.047	0.047
Replaces Stryker® 6118-119-090					
					
Aggressive Cut Diamond Cut No Tooth Offset					
BR1-19100-47	mm	100	19	1.19	1.19
	in	3.94	0.75	0.047	0.047
Replaces Stryker® 6118-119-100					
					
Aggressive Cut Diamond Cut No Tooth Offset					

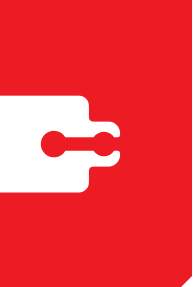

BUSA® Large Bone Saw Blades

Sagittal/Oscillating BR2000™ Proprietary (BR1 Series - Stryker®)

Compatible with Stryker® Sagittal Saw Systems: 8, 7, 6, 5, 4, 2000 & EHD

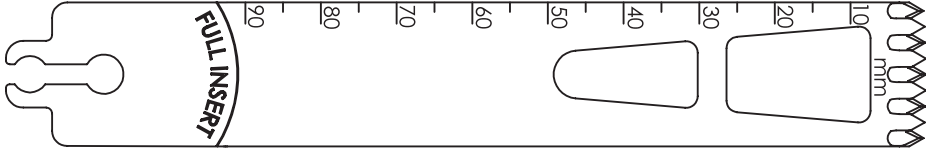
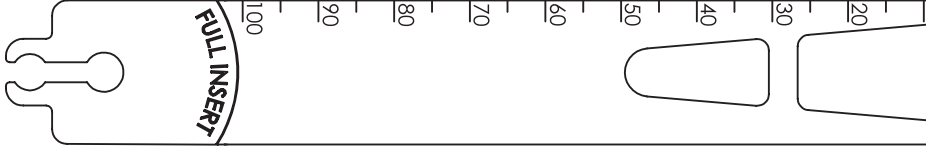
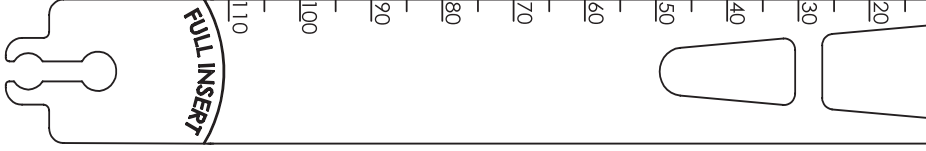
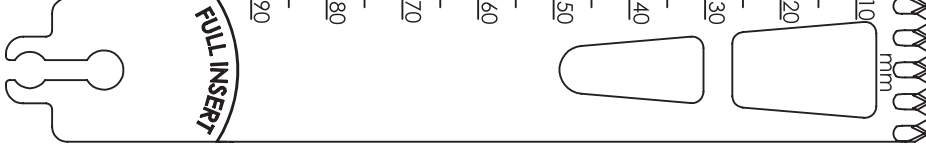
Stryker®					
Order Number	Unit	Length	Width	Material Thickness	Cut Thickness
BR1-1990-50	mm	90	19	1.27	1.27
	in	3.54	0.75	0.050	0.050
Replaces Stryker® 6118-127-090, 2108-382-000, 2108-382					
					
Aggressive Cut Diamond Cut No Tooth Offset					
BR1-19100-50	mm	100	19	1.27	1.27
	in	3.94	0.75	0.050	0.050
Replaces Stryker® 6118-127-100, 2108-385-000, 2108-385					
					
Aggressive Cut Diamond Cut No Tooth Offset					
BR1-19110-50	mm	110	19	1.27	1.27
	in	4.33	0.75	0.050	0.050
Replaces Stryker® 6118-127-110					
					
Aggressive Cut Diamond Cut No Tooth Offset					
BR1-1990-54	mm	90	19	1.37	1.37
	in	3.54	0.75	0.054	0.054
Replaces Stryker® 6118-137-090, 2108-351-02					
					
Aggressive Cut Diamond Cut No Tooth Offset					

Compatible with Stryker® Sagittal Saw Systems: 8, 7, 6, 5, 4, 2000 & EHD

STRYKER® |

BUSA® Large Bone Saw Blades

Sagittal/Oscillating BR2000™ Proprietary (BR1 Series - Stryker®)



STRYKER® | Compatible with Stryker® Sagittal Saw Systems: 8, 7, 6, 5, 4, 2000 & EHD

Compatible with Stryker® Sagittal Saw Systems: 8, 7, 6, 5, 4, 2000 & EHD

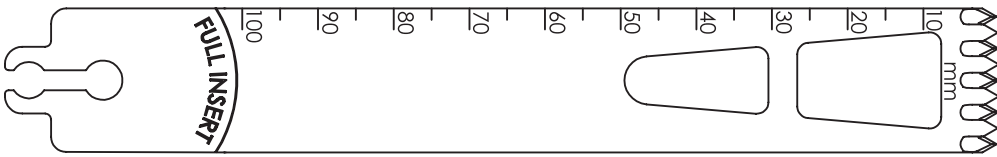
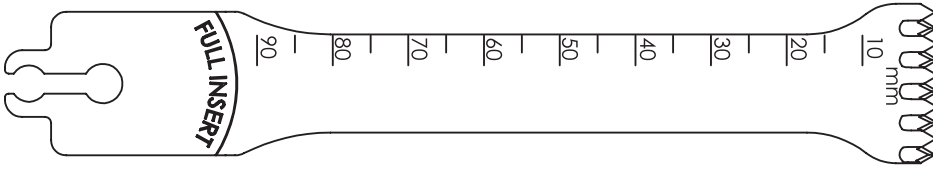
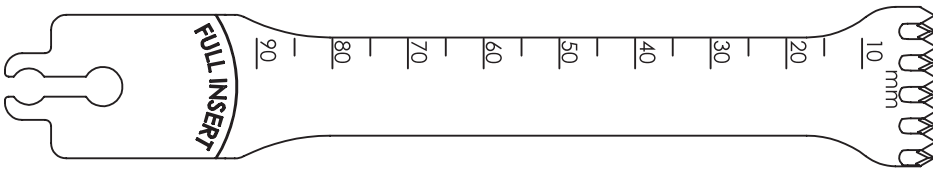
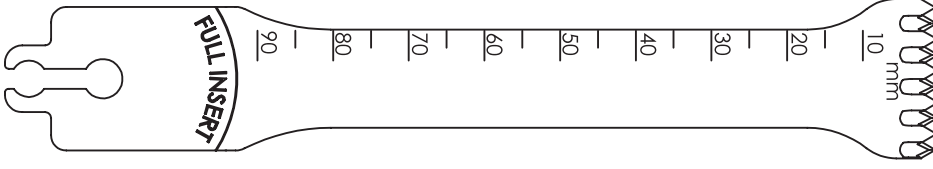
Stryker®					
Order Number	Unit	Length	Width	Material Thickness	Cut Thickness
BR1-19100-54	mm	100	19	1.37	1.37
	in	3.94	0.75	0.054	0.054
Replaces Stryker® 6118-137-100					
					
Aggressive Cut Diamond Cut No Tooth Offset					
BR1-2190-39F	mm	90	21	0.99	0.99
	in	3.54	0.83	0.039	0.039
Replaces Stryker® 6221-100-090					
					
Aggressive Cut Diamond Cut No Tooth Offset Flared Blade					
BR1-2190-47F	mm	90	21	1.19	1.19
	in	3.54	0.83	0.047	0.047
Replaces Stryker® 6221-119-090, 4221-120-085					
					
Aggressive Cut Diamond Cut No Tooth Offset Flared Blade					
BR1-2190-50F	mm	90	21	1.27	1.27
	in	3.54	0.83	0.050	0.050
Replaces Stryker® 6221-127-090, 2108-382-001, 2108-382-1, 2108-382-003, 21080382-3					
					
Aggressive Cut Diamond Cut No Tooth Offset Flared Blade					

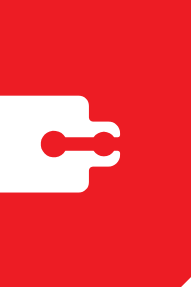

BUSA® Large Bone Saw Blades

Sagittal/Oscillating BR2000™ Proprietary (BR1 Series - Stryker®)

Compatible with Stryker® Sagittal Saw Systems: 8, 7, 6, 5, 4, 2000 & EHD

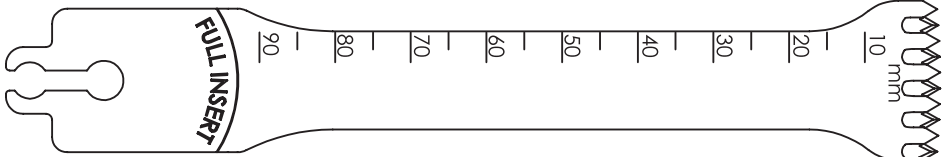
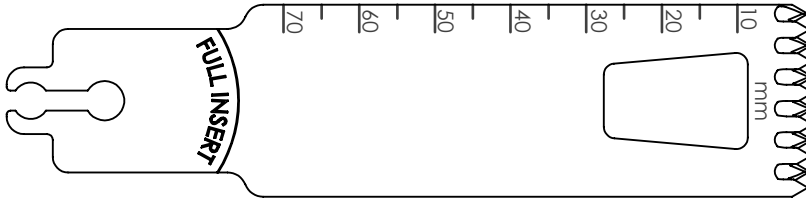
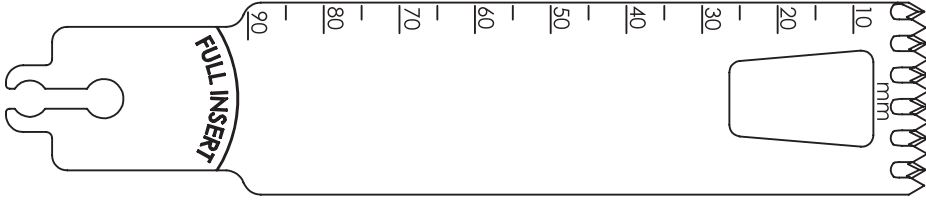
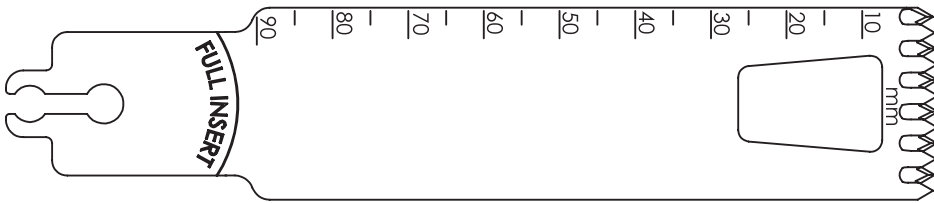
Stryker®					
Order Number	Unit	Length	Width	Material Thickness	Cut Thickness
BR1-2190-54F	mm	90	21	1.37	1.37
	in	3.54	0.83	0.054	0.054
Replaces Stryker® 6221-137-090, 2108-382-002, 2108-382-2					
					
Aggressive Cut Diamond Cut No Tooth Offset Flared Blade					
BR1-2575-35	mm	75	25	0.89	0.89
	in	2.95	0.98	0.035	0.035
Replaces Stryker® 6125-089-075					
					
Aggressive Cut Diamond Cut No Tooth Offset					
BR1-2590-35	mm	90	25	0.89	0.89
	in	3.54	0.98	0.035	0.035
Replaces Stryker® 6125-089-090, 2108-302-000, 2108-302, 2108-102-003, 2108-102-008					
					
Aggressive Cut Diamond Cut No Tooth Offset					
BR1-2590-39	mm	90	25	0.99	0.99
	in	3.54	0.98	0.039	0.039
Replaces Stryker® 6125-097-090, 2108-393-006, 2108-393-6					
					
Aggressive Cut Diamond Cut No Tooth Offset					

Compatible with Stryker® Sagittal Saw Systems: 8, 7, 6, 5, 4, 2000 & EHD

STRYKER®

BUSA® Large Bone Saw Blades

Sagittal/Oscillating BR2000™ Proprietary (BR1 Series - Stryker®)



STRYKER® | Compatible with Stryker® Sagittal Saw Systems: 8, 7, 6, 5, 4, 2000 & EHD

Compatible with Stryker® Sagittal Saw Systems: 8, 7, 6, 5, 4, 2000 & EHD

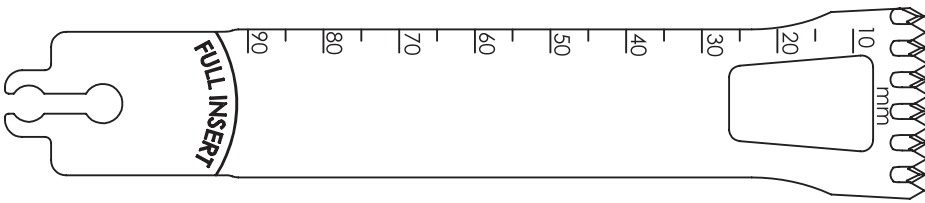
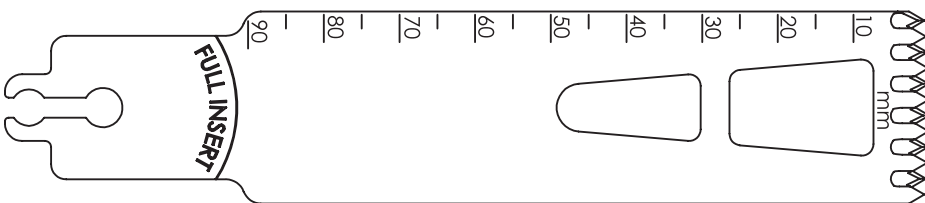
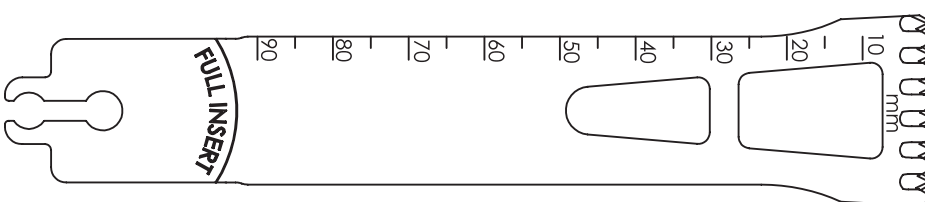
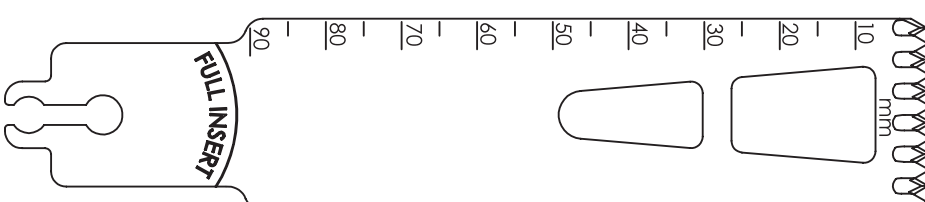
Stryker®					
Order Number	Unit	Length	Width	Material Thickness	Cut Thickness
BR1-2590-39F	mm	90	25	0.99	0.99
	in	3.54	0.98	0.039	0.039
Replaces Stryker® 2108-393-005, 2108-393-5					
					
Aggressive Cut Diamond Cut No Tooth Offset Flared Blade					
BR1-2590-47	mm	90	25	1.19	1.19
	in	3.54	0.98	0.047	0.047
Replaces Stryker® 6125-119-090, 2108-351-000, 2108-351					
					
Aggressive Cut Diamond Cut No Tooth Offset					
BR1-2590-47F	mm	90	25	1.19	1.19
	in	3.54	0.98	0.047	0.047
Replaces Stryker® 2108-351-002, 2108-351-2					
					
Aggressive Cut Diamond Cut No Tooth Offset Flared Blade					
BR1-2590-50	mm	90	25	1.27	1.27
	in	3.54	0.98	0.050	0.050
Replaces Stryker® 6125-127-090, 2108-376-002, 2108-386-2					
					
Aggressive Cut Diamond Cut No Tooth Offset					

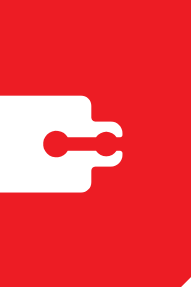

BUSA® Large Bone Saw Blades

Sagittal/Oscillating BR2000™ Proprietary (BR1 Series - Stryker®)

Compatible with Stryker® Sagittal Saw Systems: 8, 7, 6, 5, 4, 2000 & EHD

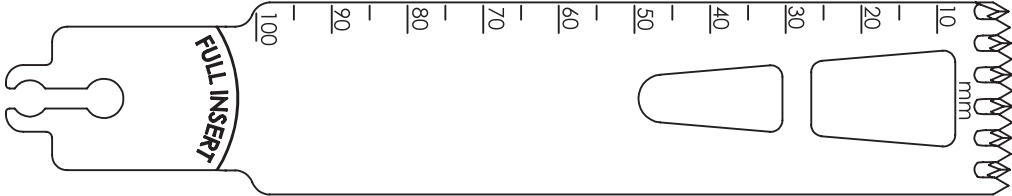
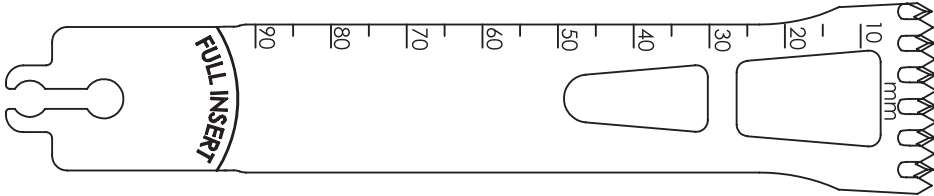
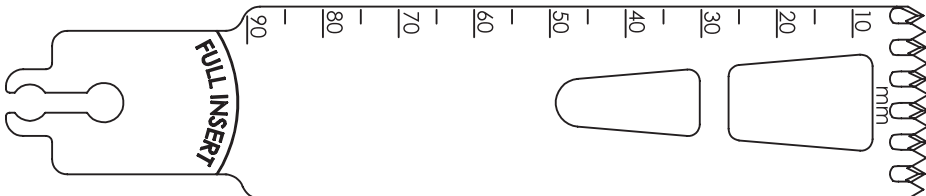
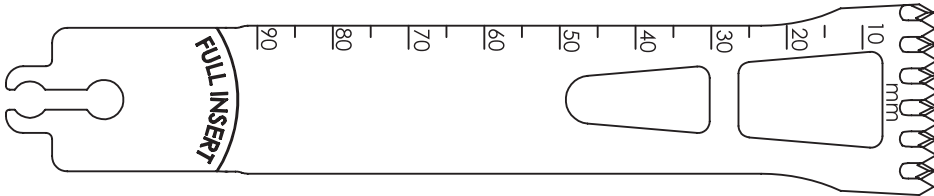
Stryker®					
Order Number	Unit	Length	Width	Material Thickness	Cut Thickness
BR1-25100-50	mm	100	25	1.27	1.27
	in	3.94	0.98	0.050	0.050
Replaces Stryker® 6125-127-100 & 2108-328-000, 2108-328					
					
Aggressive Cut Diamond Cut No Tooth Offset					
BR1-2590-50F	mm	90	25	1.27	1.27
	in	3.54	0.98	0.050	0.050
Replaces Stryker® 2108-383-000, 2108-383					
					
Aggressive Cut Diamond Cut No Tooth Offset Flared Blade					
BR1-2590-54	mm	90	25	1.37	1.37
	in	3.54	0.98	0.054	0.054
Replaces Stryker® 6125-137-090					
					
Aggressive Cut Diamond Cut No Tooth Offset					
BR1-2590-54F	mm	90	25	1.37	1.37
	in	3.54	0.98	0.054	0.054
Replaces Stryker® N/A					
					
Aggressive Cut Diamond Cut No Tooth Offset Flared Blade					

Compatible with Stryker® Sagittal Saw Systems: 8, 7, 6, 5, 4, 2000 & EHD

STRYKER®

BUSA® Large Bone Saw Blades

Sagittal/Oscillating BR2000™ Proprietary (BR1 Series - Stryker®)



STRYKER® | Compatible with Stryker® Sagittal Saw Systems: 8, 7, 6, 5, 4, 2000 & EHD

Compatible with Stryker® Sagittal Saw Systems: 8, 7, 6, 5, 4, 2000 & EHD

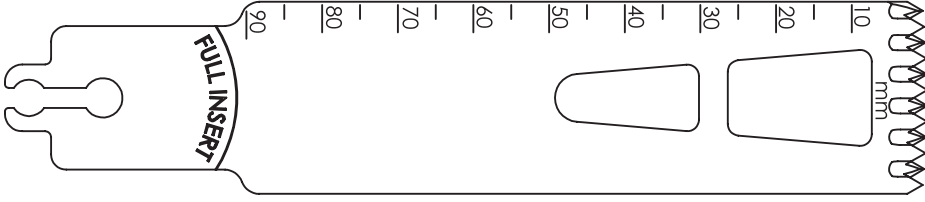
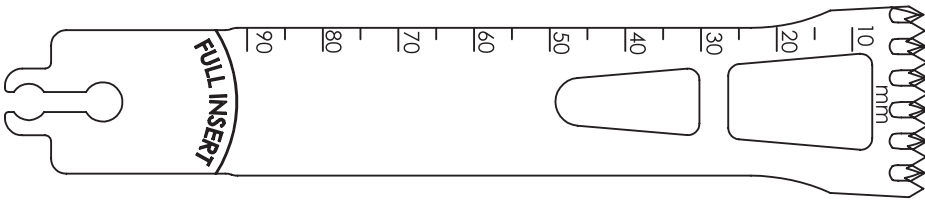
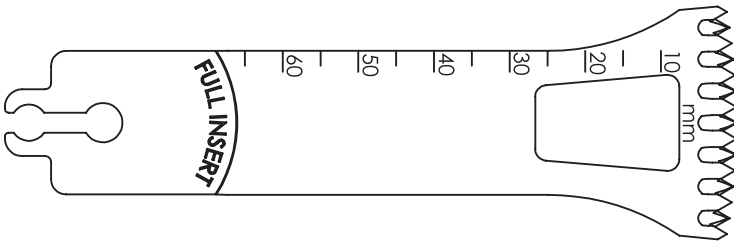
Stryker®					
Order Number	Unit	Length	Width	Material Thickness	Cut Thickness
BR1-2590-58	mm	90	25	1.47	1.47
	in	3.54	0.98	0.058	0.058
Replaces Stryker® 6125-147-090, 2108-176-002, 2108-176-003					
					
Aggressive Cut Diamond Cut No Tooth Offset					
BR1-2590-58F	mm	90	25	1.47	1.47
	in	3.54	0.98	0.058	0.058
Replaces Stryker® N/A					
					
Aggressive Cut Diamond Cut No Tooth Offset Flared Blade					
BR1-3165-39F	mm	65	31	0.99	0.99
	in	2.56	1.22	0.039	0.039
Replaces Stryker® N/A					
					
Aggressive Cut Diamond Cut No Tooth Offset Flared Blade					

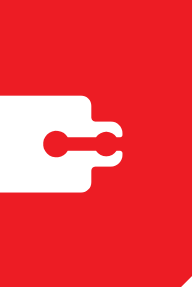

BUSA® Large Bone Saw Blades Sagittal Stryker® Replacements

Compatible with Stryker® Sagittal Saw Systems: 8, 7, 6, 5, 4, 2000 & EHD

Stryker®					
Order Number	Unit	Length	Width	Material Thickness	Cut Thickness
BR4111-119-090	mm	90	11	0.99	1.19
	in	3.54	0.43	0.039	0.047
Replaces Stryker® 4111-119-090					
					Aggressive Cut Tooth Offset
BR4111-127-090	mm	90	11	1.14	1.27
	in	3.54	0.43	0.045	0.050
Replaces Stryker® 4111-127-090					
					Aggressive Cut Tooth Offset
BR4111-135-090	mm	90	11	1.19	1.35
	in	3.54	0.43	0.047	0.053
Replaces Stryker® 4111-135-090					
					Aggressive Cut Tooth Offset
BR4111-147-075	mm	75	11	1.37	1.47
	in	2.95	0.43	0.054	0.058
Replaces Stryker® 4111-147-075					
					Aggressive Cut Tooth Offset

Compatible with Stryker® Sagittal Saw Systems: 8, 7, 6, 5, 4, 2000 & EHD

STRYKER® |

BUSA® Large Bone Saw Blades Sagittal Stryker® Replacements



STRYKER® | Compatible with Stryker® Sagittal Saw Systems: 8, 7, 6, 5, 4, 2000 & EHD

Compatible with Stryker® Sagittal Saw Systems: 8, 7, 6, 5, 4, 2000 & EHD

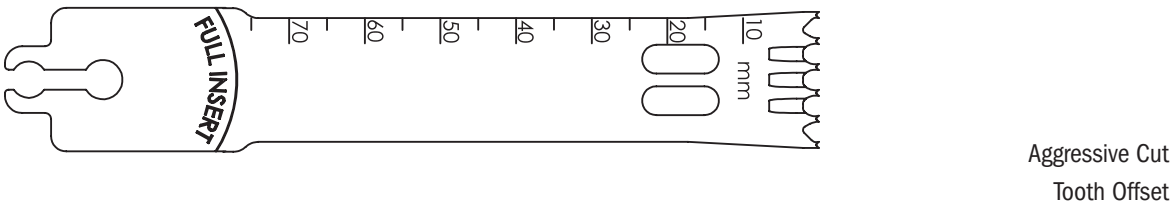
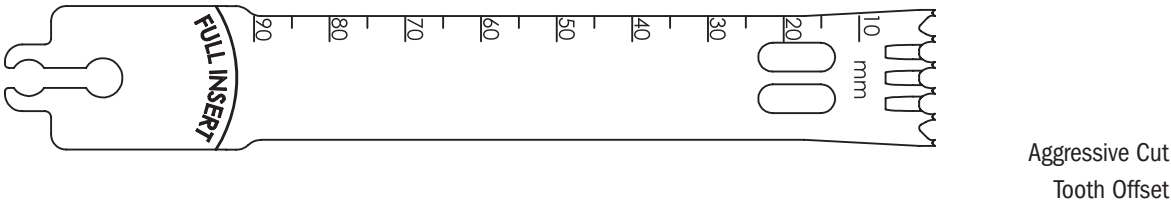
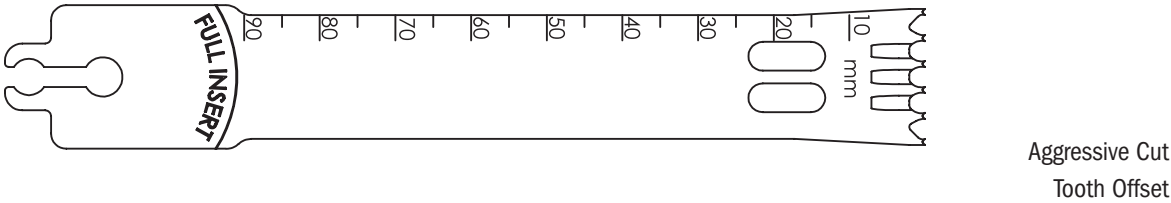
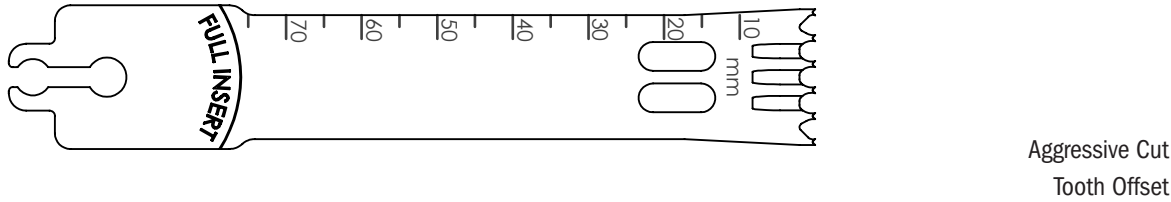
Stryker®					
Order Number	Unit	Length	Width	Material Thickness	Cut Thickness
BR4118-089-075	mm	75	18	0.79	0.89
	in	2.95	0.71	0.031	0.035
Replaces Stryker® 4118-089-075					
					
BR4118-089-090	mm	90	18	0.79	0.89
	in	3.54	0.71	0.031	0.035
Replaces Stryker® 4118-089-090					
					
BR4118-119-090	mm	90	18	0.99	1.19
	in	3.54	0.71	0.039	0.047
Replaces Stryker® 4118-119-090					
					
BR4118-127-075	mm	75	18	1.13	1.27
	in	2.95	0.71	0.044	0.050
Replaces Stryker® 4118-127-075					
					

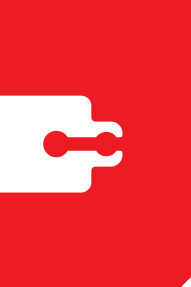

BUSA® Large Bone Saw Blades Sagittal Stryker® Replacements

Compatible with Stryker® Sagittal Saw Systems: 8, 7, 6, 5, 4, 2000 & EHD

Stryker®					
Order Number	Unit	Length	Width	Material Thickness	Cut Thickness
BR4118-127-090	mm	90	18	1.14	1.27
	in	3.54	0.71	0.045	0.050
Replaces Stryker® 4118-127-090					
BR4118-127-100	mm	100	18	1.14	1.27
	in	3.94	0.71	0.045	0.050
Replaces Stryker® 4118-127-100					
BR4118-135-090	mm	90	18	1.19	1.35
	in	3.54	0.71	0.047	0.053
Replaces Stryker® 4118-135-090					
BR4118-135-105	mm	105	18	1.19	1.35
	in	4.13	0.71	0.047	0.053
Replaces Stryker® 4118-135-105					

Compatible with Stryker® Sagittal Saw Systems: 8, 7, 6, 5, 4, 2000 & EHD

STRYKER® |

BUSA® Large Bone Saw Blades Sagittal Stryker® Replacements



STRYKER® | Compatible with Stryker® Sagittal Saw Systems: 8, 7, 6, 5, 4, 2000 & EHD

Compatible with Stryker® Sagittal Saw Systems: 8, 7, 6, 5, 4, 2000 & EHD

Stryker®					
Order Number	Unit	Length	Width	Material Thickness	Cut Thickness
BR4118-137-090	mm	90	18	1.27	1.37
	in	3.54	0.71	0.050	0.054
Replaces Stryker® 4118-137-090					
Aggressive Cut Tooth Offset					
BR4125-089-075	mm	75	25	0.79	0.89
	in	2.95	0.98	0.031	0.035
Replaces Stryker® 4125-089-075					
Aggressive Cut Tooth Offset					
BR4125-089-090	mm	90	25	0.80	0.89
	in	3.54	0.98	0.031	0.035
Replaces Stryker® 4125-089-090					
Aggressive Cut Tooth Offset					
BR4125-097-090	mm	90	25	0.88	0.97
	in	3.54	0.98	0.035	0.038
Replaces Stryker® 4125-097-090					
Aggressive Cut Tooth Offset					

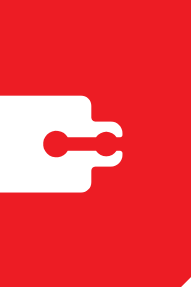

BUSA® Large Bone Saw Blades Sagittal Stryker® Replacements

Compatible with Stryker® Sagittal Saw Systems: 8, 7, 6, 5, 4, 2000 & EHD

Stryker®					
Order Number	Unit	Length	Width	Material Thickness	Cut Thickness
BR4125-107-090	mm	90	25	0.97	1.07
	in	3.54	0.98	0.038	0.042
Replaces Stryker® 4125-107-090					
BR4125-119-090	mm	90	25	0.99	1.19
	in	3.54	0.98	0.039	0.047
Replaces Stryker® 4125-119-090					
BR4125-127-090	mm	90	25	1.14	1.27
	in	3.54	0.98	0.045	0.050
Replaces Stryker® 4125-127-090					
BR4125-127-100	mm	100	25	1.14	1.27
	in	3.94	0.98	0.045	0.050
Replaces Stryker® 4125-127-100					

STRYKER® | Compatible with Stryker® Sagittal Saw Systems: 8, 7, 6, 5, 4, 2000 & EHD

BUSA® Large Bone Saw Blades Sagittal Stryker® Replacements



STRYKER® | Compatible with Stryker® Sagittal Saw Systems: 8, 7, 6, 5, 4, 2000 & EHD

Compatible with Stryker® Sagittal Saw Systems: 8, 7, 6, 5, 4, 2000 & EHD

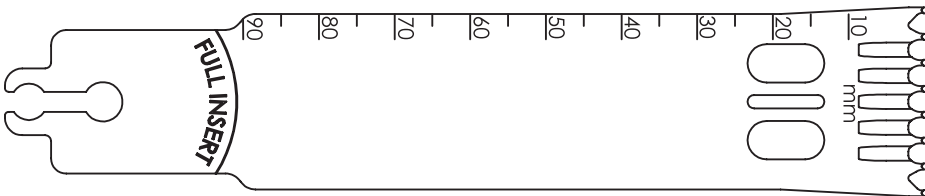
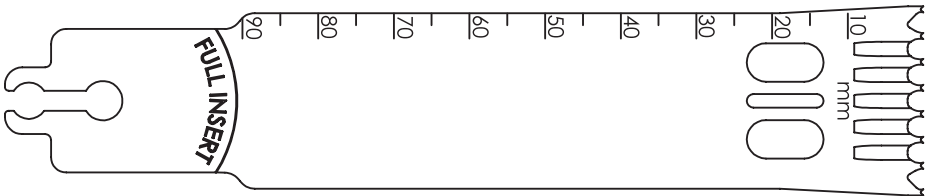
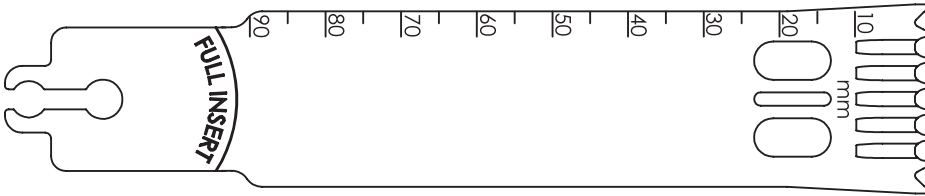
Stryker®					
Order Number	Unit	Length	Width	Material Thickness	Cut Thickness
BR4125-135-090	mm	90	25	1.19	1.35
	in	3.54	0.98	0.047	0.053
Replaces Stryker® 4125-135-090					
 <p style="text-align: right;">Aggressive Cut Tooth Offset</p>					
BR4125-137-090	mm	90	25	1.27	1.37
	in	3.54	0.98	0.050	0.054
Replaces Stryker® 4125-137-090					
 <p style="text-align: right;">Aggressive Cut Tooth Offset</p>					
BR4125-147-090	mm	90	25	1.37	1.47
	in	3.54	0.98	0.054	0.058
Replaces Stryker® 4125-147-090					
 <p style="text-align: right;">Aggressive Cut Tooth Offset</p>					

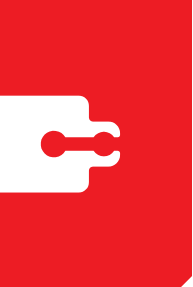

BUSA® Large Bone Saw Blades Sagittal Stryker® Replacements

Compatible with Stryker® Sagittal Saw Systems: 8, 7, 6, 5, 4, 2000 & EHD

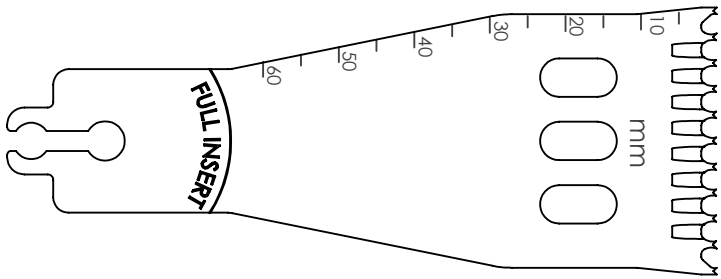
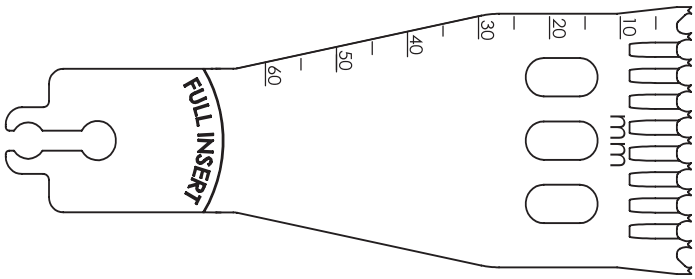
Stryker®					
Order Number	Unit	Length	Width	Material Thickness	Cut Thickness
BR4135-089-064	mm	64	35	0.80	0.89
	in	2.52	1.38	0.031	0.035
Replaces Stryker® 4135-089-064					
 <p style="text-align: right;">Aggressive Cut Tooth Offset</p>					
BR2108-107-4S1	mm	60	35	1.19	1.35
	in	2.36	1.38	0.047	0.053
Replaces Stryker® 2108-107-4S1 & 2108-107-4SI					
 <p style="text-align: right;">Aggressive Cut Tooth Offset Specialty</p>					

STRYKER® | Compatible with Stryker® Sagittal Saw Systems: 8, 7, 6, 5, 4, 2000 & EHD

BUSA® Large Bone Saw Blades Sagittal Stryker® Replacements



STRYKER® | Compatible with Stryker® Sagittal Saw Systems: 8, 7, 6, 5, 4, 2000 & EHD

Compatible with Stryker® Sagittal Saw Systems: 8, 7, 6, 5, 4, 2000 & EHD

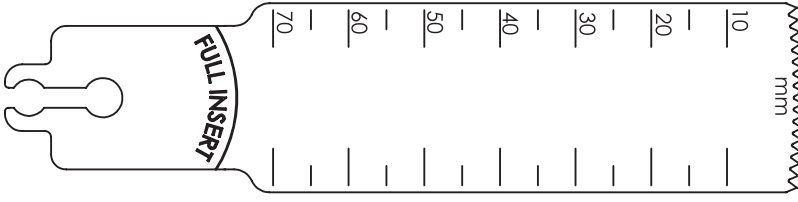
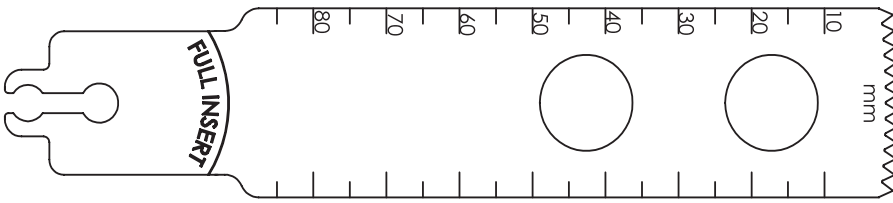
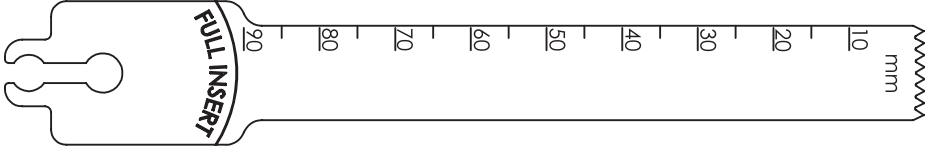
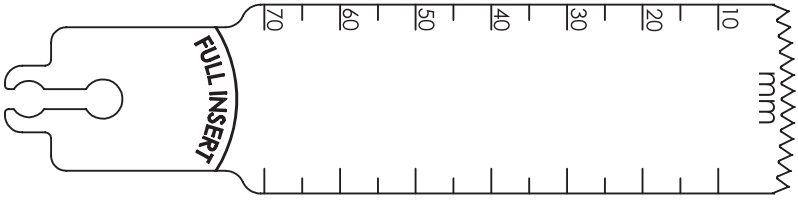
Stryker®					
Order Number	Unit	Length	Width	Material Thickness	Cut Thickness
BR2108-100	mm	70	25	0.64	0.99
	in	2.76	0.98	0.025	0.039
Replaces Stryker® 2108-100-000, 2108-100					
					
Tooth Offset					
BR2108-102	mm	85	25	0.89	0.94
	in	3.35	0.98	0.035	0.037
Replaces Stryker® 2108-102-000, 2108-102					
					
Tooth Offset					
BR2108-103	mm	90	12.5	0.89	0.99
	in	3.54	0.49	0.035	0.039
Replaces Stryker® 2108-103-000, 2108-103					
					
Tooth Offset					
BR2108-105	mm	70	25	0.89	0.94
	in	2.76	0.98	0.035	0.037
Replaces Stryker® 2108-105-000, 2108-105					
					
Tooth Offset					

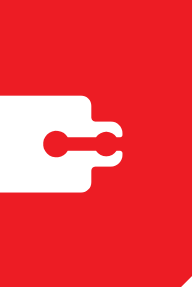

BUSA® Large Bone Saw Blades Sagittal Stryker® Replacements

Compatible with Stryker® Sagittal Saw Systems: 8, 7, 6, 5, 4, 2000 & EHD

Stryker®

Order Number	Unit	Length	Width	Material Thickness	Cut Thickness
BR2108-107-1	mm	73	29	0.89	0.97
	in	2.87	1.14	0.035	0.038

Replaces Stryker® 2108-107-001

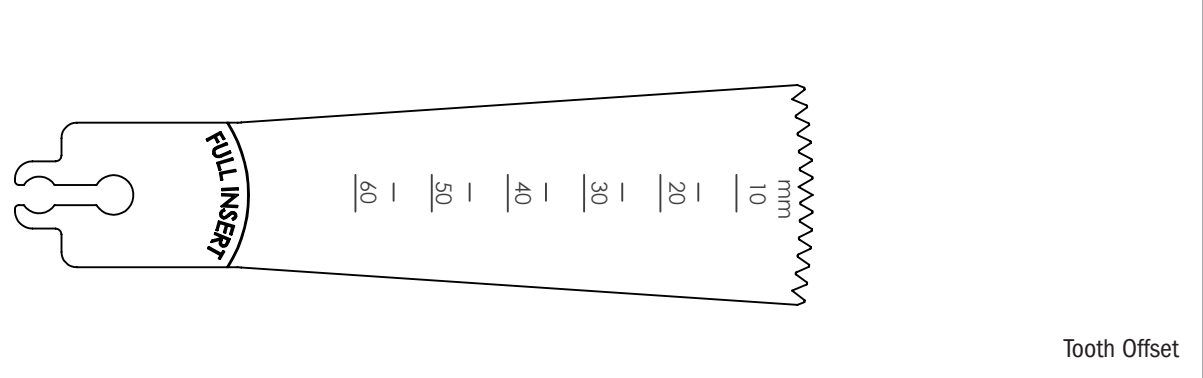

BR2108-107-4	mm	64	36	1.19	1.55
	in	2.52	1.42	0.047	0.061

Replaces Stryker® 2108-107-004

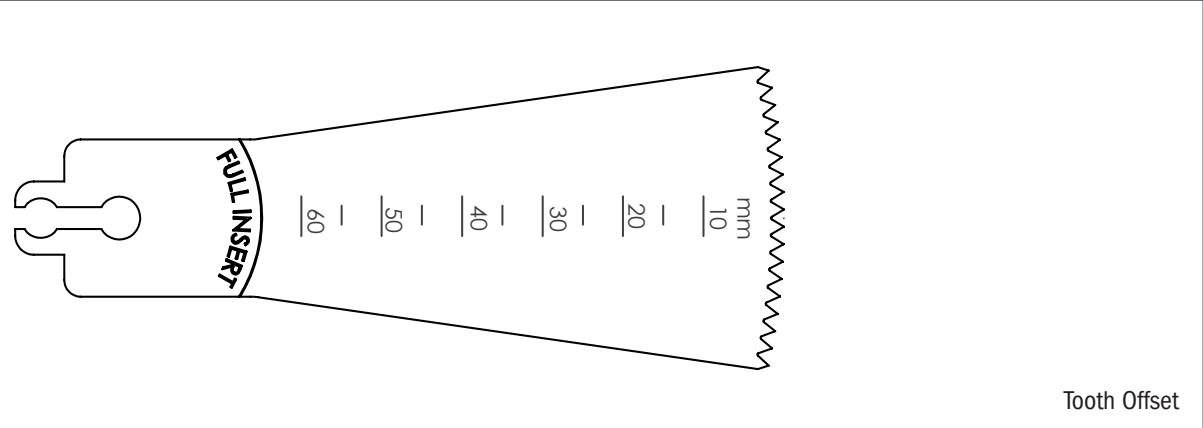

BR2108-107-4S1	mm	60	35	1.19	1.35
	in	2.36	1.38	0.047	0.053

Replaces Stryker® 2108-107-4S1, 2108-107-4SI

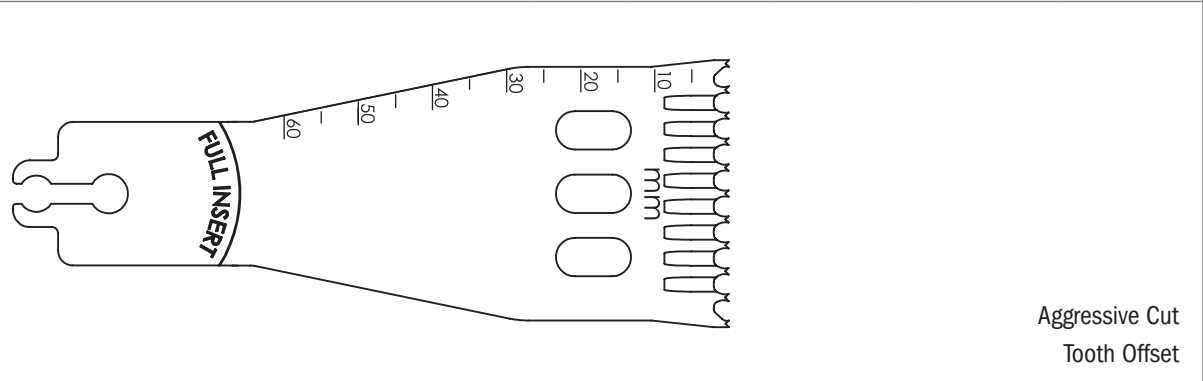



STRYKER® | Compatible with Stryker® Sagittal Saw Systems: 8, 7, 6, 5, 4, 2000 & EHD

BUSA® Large Bone Saw Blades Sagittal Stryker® Replacements

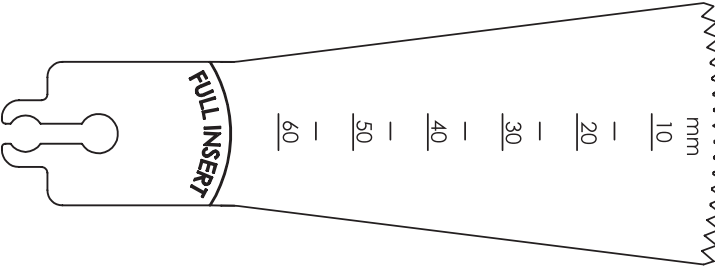

STRYKER® | Compatible with Stryker® Sagittal Saw Systems: 8, 7, 6, 5, 4, 2000 & EHD

Compatible with Stryker® Sagittal Saw Systems: 8, 7, 6, 5, 4, 2000 & EHD

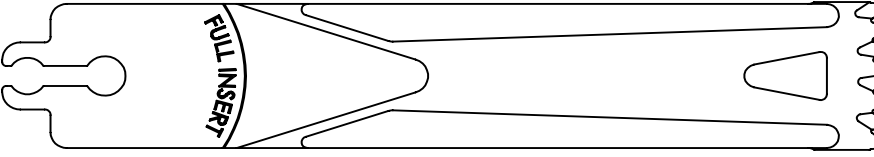
Stryker®					
Order Number	Unit	Length	Width	Material Thickness	Cut Thickness
BR2108-107-9	mm	60	34.5	0.79	0.79
	in	2.36	1.36	0.031	0.031
Replaces Stryker® 2108-107-009, 2108-107-9					
					
No Tooth Offset					
BR2108-109	mm	80	21	0.89	0.94
	in	3.15	0.83	0.035	0.037
Replaces Stryker® 2108-109-000, 2108-109					
					
Tooth Offset					
BR2108-109-000S9	mm	81	20	1.27	1.27
	in	3.19	0.79	0.05	0.05
Replaces Stryker® 2108-109-000S9					
					
Tooth Offset					

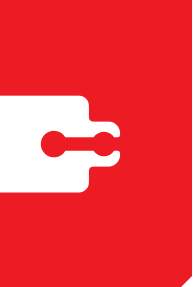

BUSA® Large Bone Saw Blades Sagittal Stryker® Replacements

Compatible with Stryker® Sagittal Saw Systems: 8, 7, 6, 5, 4, 2000 & EHD

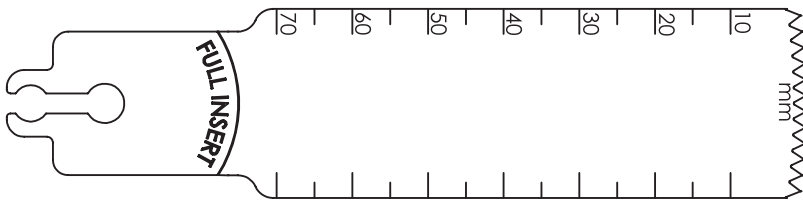
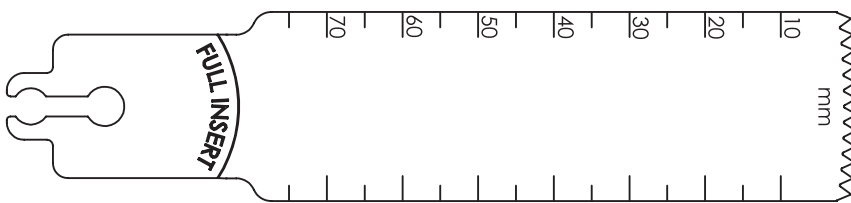
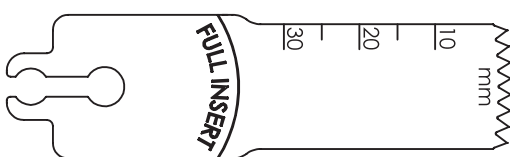
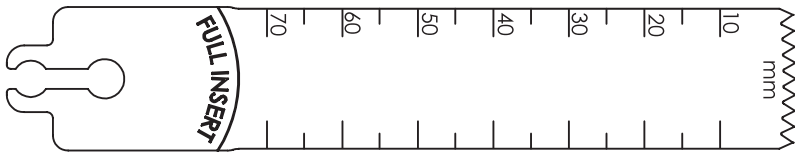
Stryker®					
Order Number	Unit	Length	Width	Material Thickness	Cut Thickness
BR2108-110	mm	70	25	1.27	1.47
	in	2.76	0.98	0.050	0.058
Replaces Stryker® 2108-110-000, 2108-110					
					
Tooth Offset					
BR2108-111	mm	75	25	1.27	1.47
	in	2.95	0.98	0.050	0.058
Replaces Stryker® 2108-111-000, 2108-111					
					
Tooth Offset					
BR2108-113	mm	30	16.5	1.27	1.65
	in	1.18	0.65	0.050	0.065
Replaces Stryker® 2108-113-000, 2108-113					
					
Tooth Offset					
BR2108-115	mm	70	18.5	0.79	0.91
	in	2.76	0.73	0.031	0.036
Replaces Stryker® 2108-115-000, 2108-115					
					
Tooth Offset					

STRYKER® | Compatible with Stryker® Sagittal Saw Systems: 8, 7, 6, 5, 4, 2000 & EHD

BUSA® Large Bone Saw Blades Sagittal Stryker® Replacements



STRYKER® | Compatible with Stryker® Sagittal Saw Systems: 8, 7, 6, 5, 4, 2000 & EHD

Compatible with Stryker® Sagittal Saw Systems: 8, 7, 6, 5, 4, 2000 & EHD

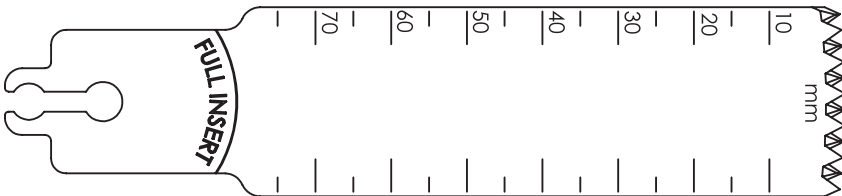
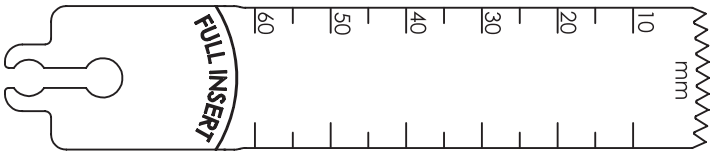
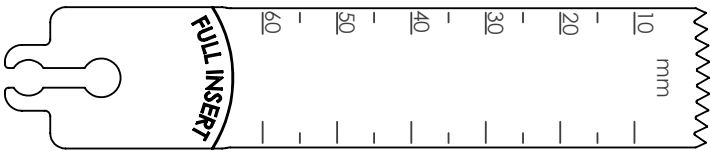
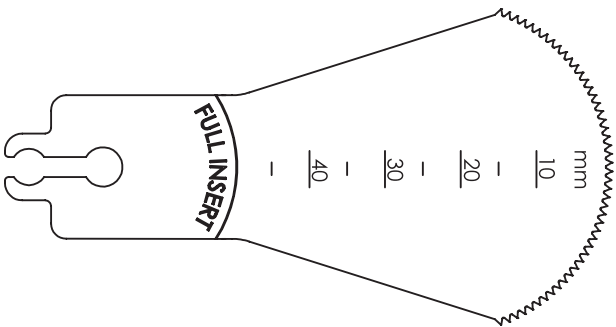
Stryker®					
Order Number	Unit	Length	Width	Material Thickness	Cut Thickness
BR2108-118	mm	75	25	1.27	1.27
	in	2.95	0.98	0.050	0.050
Replaces Stryker® 2108-118-000, 2108-118					
 <p style="text-align: right;">No Tooth Offset Diamond Tooth Design</p>					
BR2108-120	mm	60	18.5	0.64	0.97
	in	2.36	0.73	0.025	0.038
Replaces Stryker® 2108-120-000, 2108-120					
 <p style="text-align: right;">Tooth Offset</p>					
BR2108-120-6	mm	63	19	0.64	0.91
	in	2.48	0.73	0.025	0.036
Replaces Stryker® 2108-120-006					
 <p style="text-align: right;">Tooth Offset</p>					
BR2108-125	mm	45	42	0.64	1.02
	in	1.77	1.65	0.025	0.040
Replaces Stryker® 2108-125-000, 2108-125					
 <p style="text-align: right;">Repeat Sternotomy Blade Tooth Offset</p>					

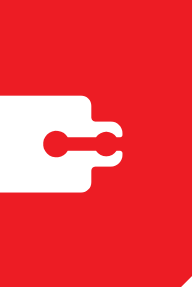

BUSA® Large Bone Saw Blades Sagittal Stryker® Replacements

Compatible with Stryker® Sagittal Saw Systems: 8, 7, 6, 5, 4, 2000 & EHD

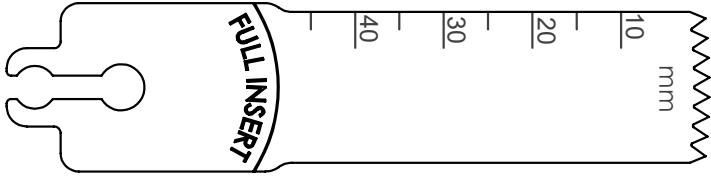
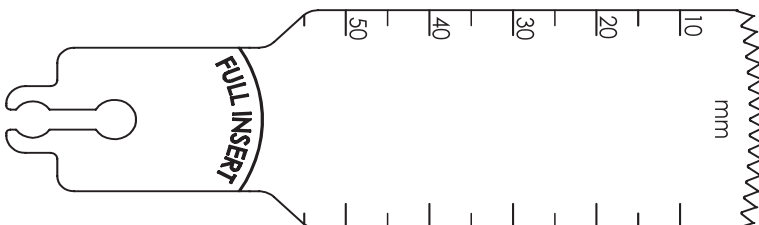
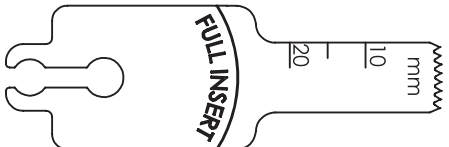
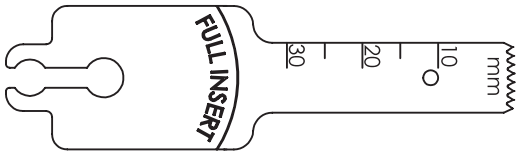
Stryker®					
Order Number	Unit	Length	Width	Material Thickness	Cut Thickness
BR2108-131	mm	47.5	18	0.64	1.04
	in	1.87	0.69	0.025	0.041
Replaces Stryker® 2108-131-000					
					Tooth Offset
BR2108-140	mm	55	29	0.64	1.02
	in	2.17	1.14	0.025	0.040
Replaces Stryker® 2108-140-000, 2108-140					
					Tooth Offset
BR2108-145	mm	20	9	0.64	0.79
	in	0.79	0.35	0.025	0.031
Replaces Stryker® 2108-145-000, 2108-145					
					Tooth Offset
BR2108-148	mm	30	9	0.64	0.79
	in	1.18	0.35	0.025	0.031
Replaces Stryker® 2108-148-000, 2108-148					
					ACL Blade Tooth Offset

STRYKER® | Compatible with Stryker® Sagittal Saw Systems: 8, 7, 6, 5, 4, 2000 & EHD

BUSA® Large Bone Saw Blades Sagittal Stryker® Replacements



STRYKER® | Compatible with Stryker® Sagittal Saw Systems: 8, 7, 6, 5, 4, 2000 & EHD

Compatible with Stryker® Sagittal Saw Systems: 8, 7, 6, 5, 4, 2000 & EHD

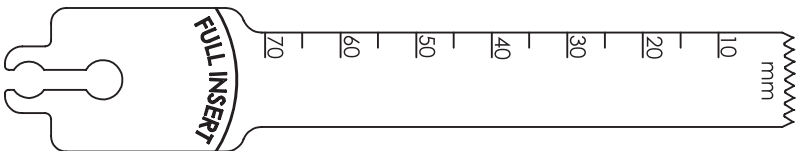
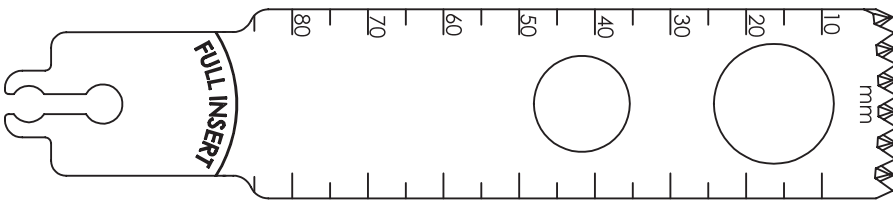
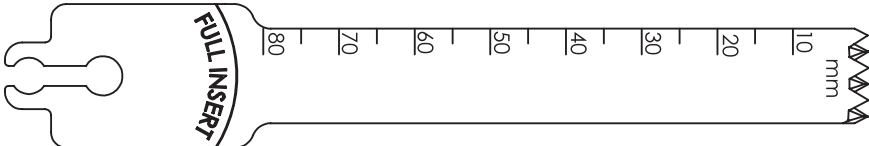
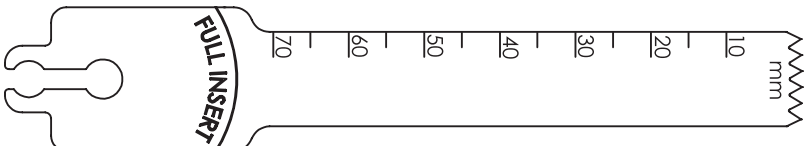
Stryker®					
Order Number	Unit	Length	Width	Material Thickness	Cut Thickness
BR2108-150	mm	70	12.5	0.64	0.99
	in	2.76	0.49	0.025	0.039
Replaces Stryker® 2108-150-000, 2108-150					
					
Tooth Offset					
BR2108-151	mm	85	25	1.19	1.19
	in	3.35	0.98	0.047	0.047
Replaces Stryker® 2108-151-000, 2108-151					
					
No Tooth Offset Diamond Tooth Design					
BR2108-152	mm	80	12.5	1.19	1.19
	in	3.15	0.49	0.047	0.047
Replaces Stryker® 2108-152-000, 2108-152					
					
No Tooth Offset Diamond Tooth Design					
BR2108-155	mm	70	12.5	1.27	1.45
	in	2.76	0.49	0.050	0.057
Replaces Stryker® 2108-155-000, 2108-155					
					
Tooth Offset					

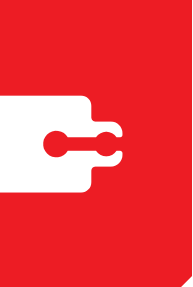

BUSA® Large Bone Saw Blades Sagittal Stryker® Replacements

Compatible with Stryker® Sagittal Saw Systems: 8, 7, 6, 5, 4, 2000 & EHD

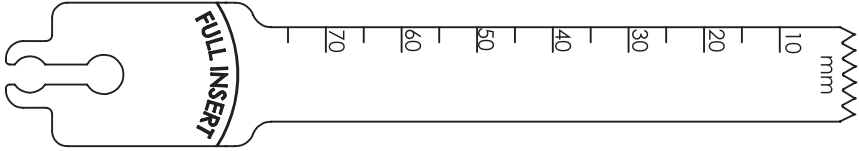
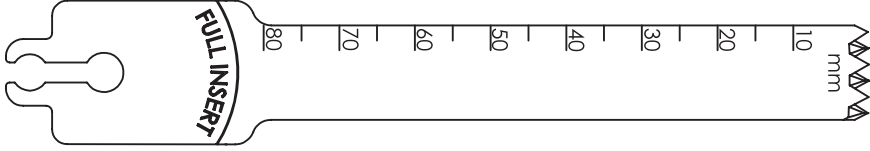
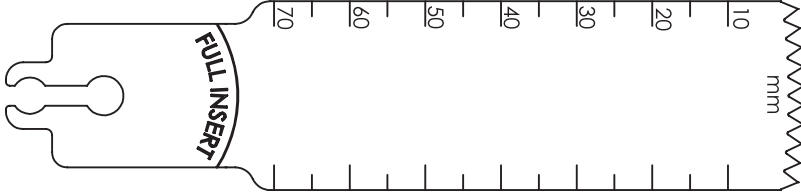
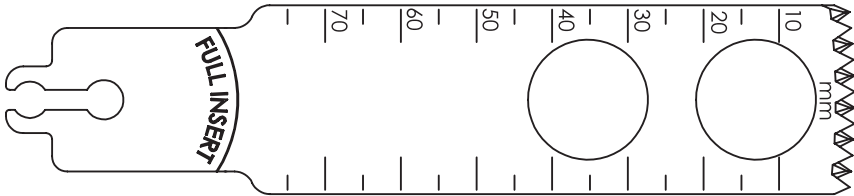
Stryker®					
Order Number	Unit	Length	Width	Material Thickness	Cut Thickness
BR2108-156	mm	75	12.5	1.27	1.45
	in	2.95	0.49	0.050	0.057
Replaces Stryker® 2108-156-000, 2108-156					
					
Tooth Offset					
BR2108-158	mm	80	12.5	1.27	1.27
	in	3.15	0.49	0.050	0.050
Replaces Stryker® 2108-158-000, 2108-158					
					
No Tooth Offset Diamond Tooth Design					
BR2108-160	mm	70	25	0.89	1.27
	in	2.76	0.98	0.035	0.050
Replaces Stryker® 2108-160-000, 2108-160					
					
Tooth Offset					
BR2108-176	mm	75	25	1.47	1.47
	in	2.95	0.98	0.058	0.058
Replaces Stryker® 2108-176-000, 2108-176					
					
No Tooth Offset Diamond Tooth Design					

Compatible with Stryker® Sagittal Saw Systems: 8, 7, 6, 5, 4, 2000 & EHD

STRYKER® |

BUSA® Large Bone Saw Blades Sagittal Stryker® Replacements



STRYKER® | Compatible with Stryker® Sagittal Saw Systems: 8, 7, 6, 5, 4, 2000 & EHD

Compatible with Stryker® Sagittal Saw Systems: 8, 7, 6, 5, 4, 2000 & EHD

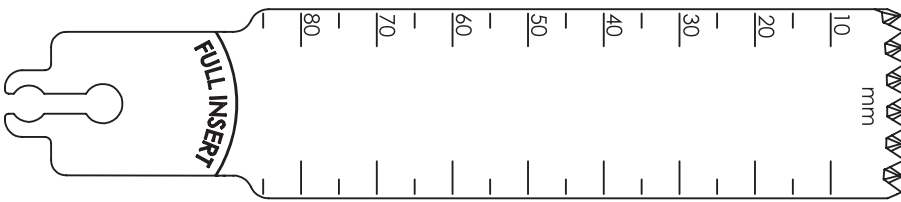
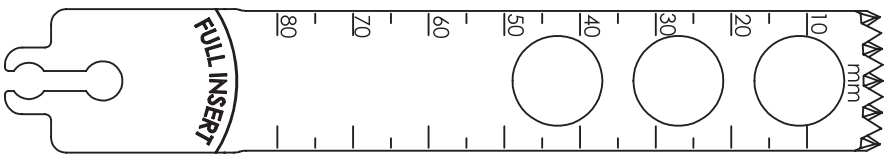
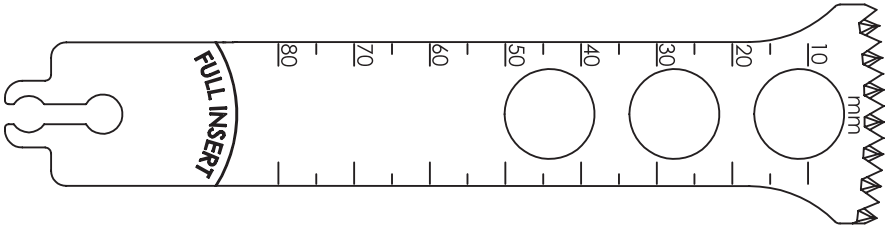
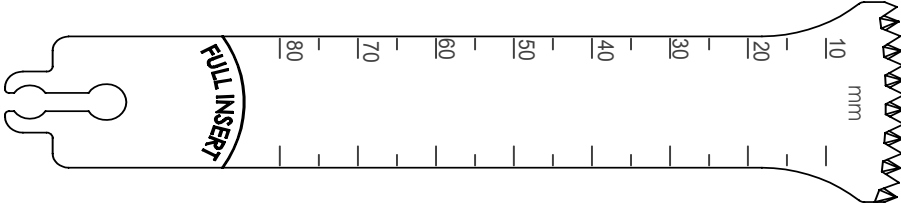
Stryker®					
Order Number	Unit	Length	Width	Material Thickness	Cut Thickness
BR2108-177	mm	85	25	1.32	1.32
	in	3.35	0.98	0.052	0.052
Replaces Stryker® 2108-177-000, 2108-177					
 <p style="text-align: right;">No Tooth Offset Diamond Tooth Design</p>					
BR2108-182	mm	80	18.5	1.27	1.27
	in	3.15	0.73	0.050	0.050
Replaces Stryker® 2108-182-000, 2108-182					
 <p style="text-align: right;">No Tooth Offset Diamond Tooth Design</p>					
BR2108-183	mm	80	29	1.27	1.27
	in	3.15	1.14	0.050	0.050
Replaces Stryker® 2108-183-000, 2108-183					
 <p style="text-align: right;">No Tooth Offset Flared Blade Diamond Tooth Design</p>					
BR2108-183-1	mm	84	29	0.97	0.97
	in	3.31	1.14	0.038	0.038
Replaces Stryker® 2108-183-001					
 <p style="text-align: right;">No Tooth Offset Aggressive Cut</p>					

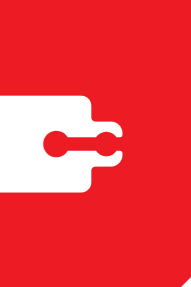

BUSA® Large Bone Saw Blades Sagittal Stryker® Replacements

Compatible with Stryker® Sagittal Saw Systems: 8, 7, 6, 5, 4, 2000 & EHD

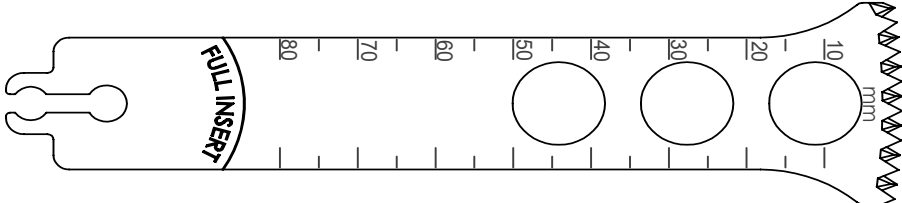
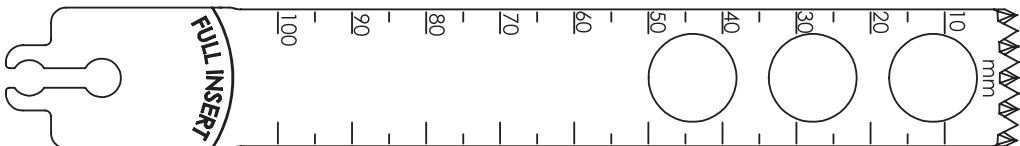
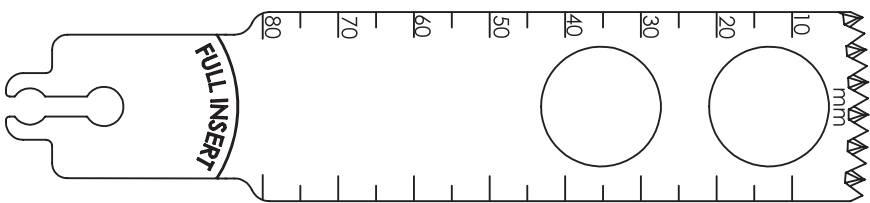
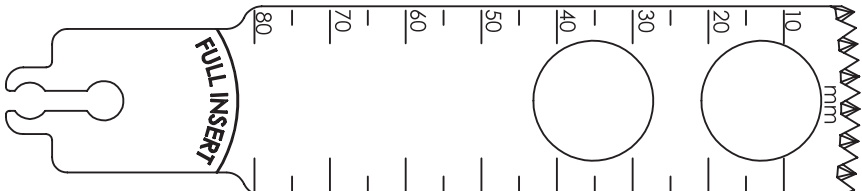
Stryker®					
Order Number	Unit	Length	Width	Material Thickness	Cut Thickness
BR2108-183-3	mm	84	29	1.32	1.32
	in	3.31	1.14	0.052	0.052
Replaces Stryker® 2108-183-003					
					
No Tooth Offset Aggressive Cut					
BR2108-185	mm	100	18.5	1.27	1.27
	in	3.94	0.73	0.050	0.050
Replaces Stryker® 2108-185-000, 2108-185					
					
No Tooth Offset Diamond Tooth Design					
BR2108-189	mm	80	25	1.27	1.27
	in	3.15	0.98	0.050	0.050
Replaces Stryker® 2108-189-000, 2108-189					
					
No Tooth Offset Diamond Tooth Design					
BR2108-193	mm	80	25	1.04	1.04
	in	3.15	0.98	0.041	0.041
Replaces Stryker® 2108-193-000, 2108-193					
					
No Tooth Offset Diamond Tooth Design					

Compatible with Stryker® Sagittal Saw Systems: 8, 7, 6, 5, 4, 2000 & EHD

STRYKER® |

BUSA® Large Bone Saw Blades Sagittal Stryker® Replacements



STRYKER® | Compatible with Stryker® Sagittal Saw Systems: 8, 7, 6, 5, 4, 2000 & EHD

Compatible with Stryker® Sagittal Saw Systems: 8, 7, 6, 5, 4, 2000 & EHD

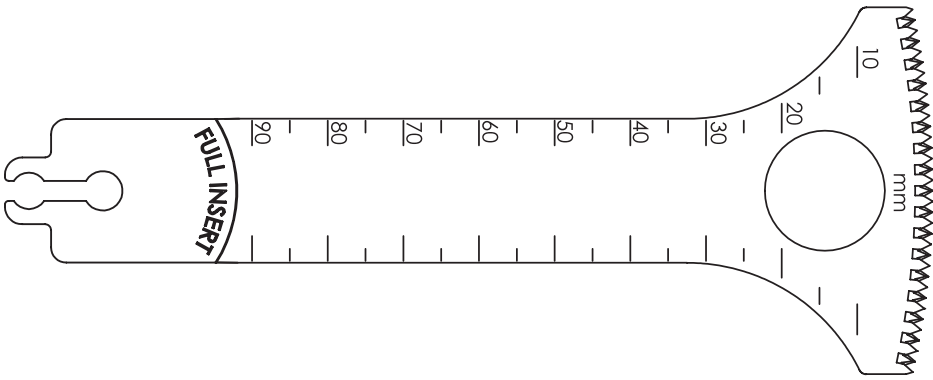
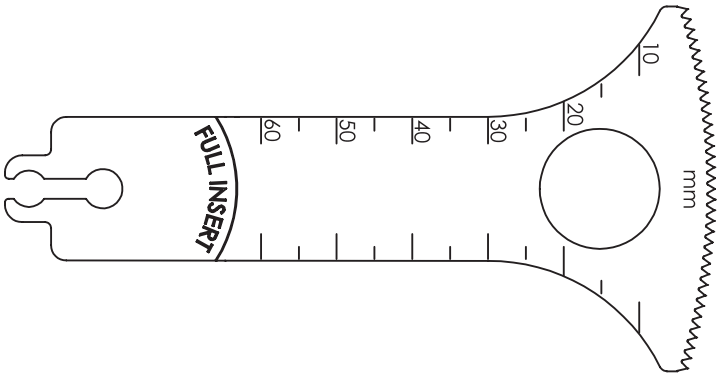
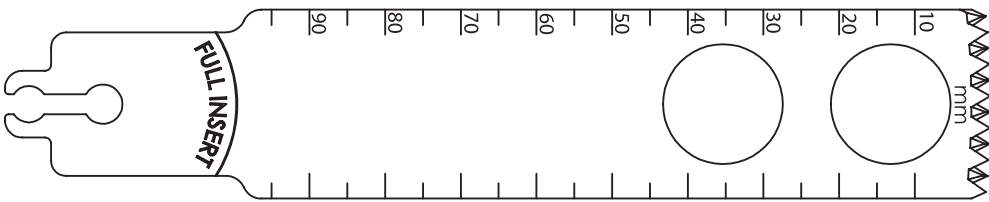
Stryker®					
Order Number	Unit	Length	Width	Material Thickness	Cut Thickness
BR2108-195	mm	90	48.5	0.99	0.99
	in	3.54	1.91	0.039	0.039
Replaces Stryker® 2108-195-000, 2108-195					
 <p>No Tooth Offset Flared Blade Diamond Tooth Design</p>					
BR2108-197	mm	60	48.5	0.64	0.99
	in	2.36	1.91	0.025	0.039
Replaces Stryker® 2108-197-000, 2108-197					
 <p>Flared Blade Tooth Offset</p>					
BR2108-218	mm	95	25	1.27	1.27
	in	3.74	0.98	0.050	0.050
Replaces Stryker® 2108-218-000, 2108-218					
 <p>No Tooth Offset Diamond Tooth Design</p>					

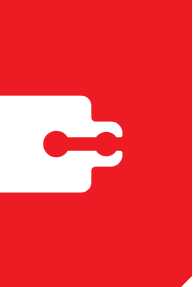

BUSA® Large Bone Saw Blades Sagittal Stryker® Replacements

Compatible with Stryker® Sagittal Saw Systems: 8, 7, 6, 5, 4, 2000 & EHD

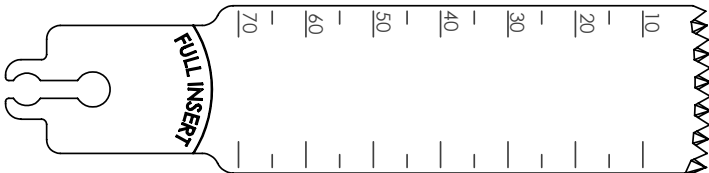
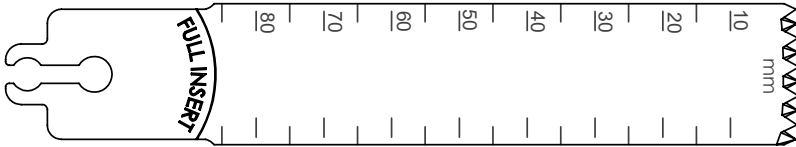
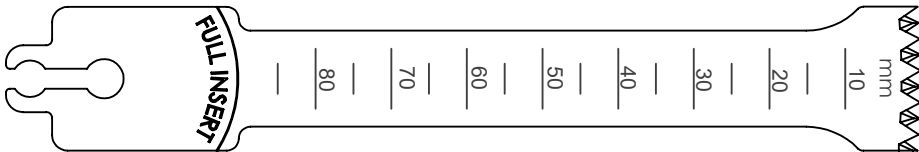
Stryker®					
Order Number	Unit	Length	Width	Material Thickness	Cut Thickness
BR2108-305	mm	73	25	0.89	0.89
	in	2.87	0.98	0.035	0.035
Replaces Stryker® 2108-305-000					
					Aggressive Cut No Tooth Offset
BR2108-309	mm	84.5	21	0.89	0.89
	in	3.33	0.83	0.035	0.035
Replaces Stryker® 2108-309-000					
					Aggressive Cut No Tooth Offset
BR2108-382-2	mm	89	19	1.37	1.37
	in	3.50	0.73	0.054	0.054
Replaces Stryker® 2108-382-002					
					Aggressive Cut No Tooth Offset

STRYKER® | Compatible with Stryker® Sagittal Saw Systems: 8, 7, 6, 5, 4, 2000 & EHD

BUSA® Large Bone Saw Blades Sagittal Stryker® Replacements

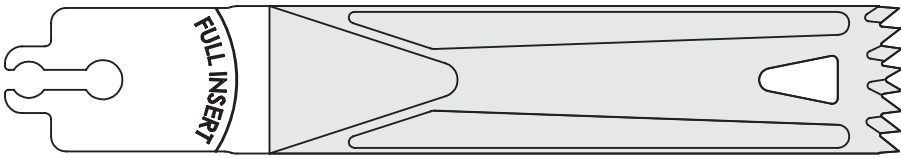
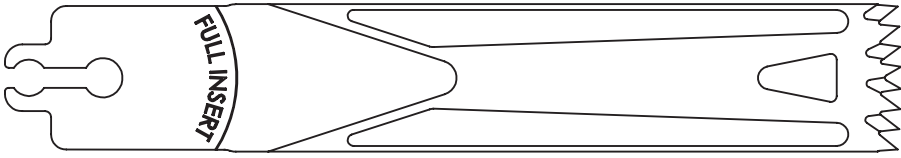

Compatible with Stryker® Sagittal Saw Systems: 8, 7, 6, 5, 4, 2000 & EHD
ConMed® Linvatec® Tooth Design

Stryker®					
Order Number	Unit	Length	Width	Material Thickness	Cut Thickness
BR5072-101	mm	86	19.5	1.27	1.27
	in	3.39	0.77	0.050	0.050
Replaces ConMed® Linvatec® 5072-101, Stryker® 2108-109-000S15					
			<p>Opposing Teeth No Tooth Offset Chromium Coating</p>		
BR5072-181	mm	86	19.5	1.27	1.27
	in	3.39	0.77	0.050	0.050
Replaces ConMed® Linvatec® 5072-18, Stryker® 2108-109-000S11					
			<p>Opposing Teeth No Tooth Offset</p>		

STRYKER®

Compatible with Stryker® Sagittal Saw Systems: 8, 7, 6, 5, 4, 2000 & EHD

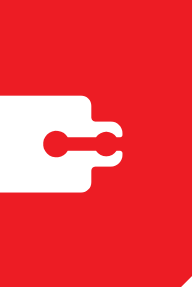

BUSA® Large Bone Saw Blades Sagittal Stryker® Replacements

Compatible with Stryker® Sagittal Saw Systems: 8, 7, 6, 5, 4, 2000 & EHD
Zimmer® Biomet® Tooth Design

Stryker®					
Order Number	Unit	Length	Width	Material Thickness	Cut Thickness
BR11-2212	mm	90	25	1.27	1.27
	in	3.54	0.98	0.050	0.050
Replaces Zimmer Biomet™ 11-2212, 25-0901-27S-G1, 25-0901-27T-G1, 25-0901-27Y-F1					
					Opposing Teeth No Tooth Offset
BR11-2214	mm	60	13	0.89	0.89
	in	2.36	0.51	0.035	0.035
Replaces Zimmer Biomet™ 1-2214, 13-0600-89S-F1, 13-0600-89T-F1, 13-0600-89Y-F1					
					Opposing Teeth No Tooth Offset
BR11-2220	mm	90	25	1.42	1.47
	in	3.54	0.98	0.056	0.058
Replaces Zimmer Biomet™ 11-2220, 25-0901-47S-B1, 25-0901-47T-B1, 25-0901-47Y-B1					
					Tooth Offset Ribbed
BR11-2222	mm	90	25	1.22	1.27
	in	3.54	0.98	0.048	0.050
Replaces Zimmer Biomet™ 11-2222, 25-0901-27S-B1, 25-0901-27T-B1, 25-0901-27Y-B1					
					Tooth Offset Ribbed

Compatible with Stryker® Sagittal Saw Systems: 8, 7, 6, 5, 4, 2000 & EHD

STRYKER®

BUSA® Large Bone Saw Blades Sagittal Stryker® Replacements



STRYKER® | Compatible with Stryker® Sagittal Saw Systems: 8, 7, 6, 5, 4, 2000 & EHD

Compatible with Stryker® Sagittal Saw Systems: 8, 7, 6, 5, 4, 2000 & EHD
Zimmer® Biomet® Tooth Design

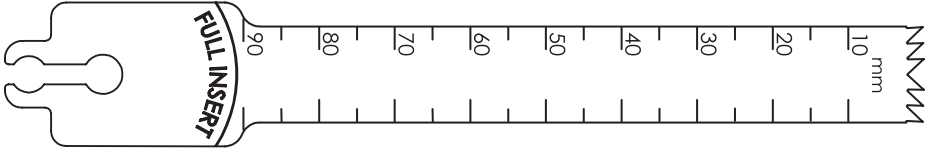
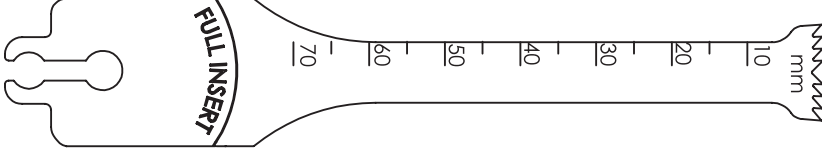
Stryker®					
Order Number	Unit	Length	Width	Material Thickness	Cut Thickness
BR11-2325	mm	90	13	1.27	1.27
	in	3.54	0.51	0.050	0.050
Replaces Zimmer Biomet™ 11-2325, 13-0901-27S-F1, 13-0901-27T-F1, 13-0901-27Y-F1					
					
Opposing Teeth No Tooth Offset					
BR11-2608	mm	70	13	1.27	1.27
	in	2.76	0.51	0.050	0.050
Replaces Zimmer Biomet™ 11-2608, 13-0701-27S-L1, 13-0701-27T-L1, 13-0701-27Y-L1; Stryker® 6213-127-070					
					
Opposing Teeth No Tooth Offset Flared Blade					

BUSA® Large Bone Saw Blades Sagittal Stryker® Replacements

Compatible with Stryker® Reciprocating Saw Systems: 8, 7, 6, 5, 4, 2000, EHD & OrthoPower

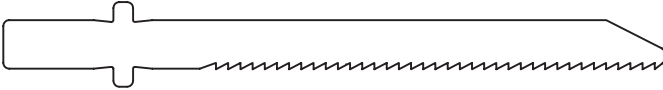
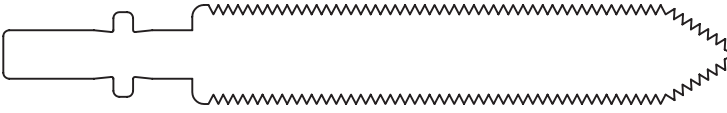
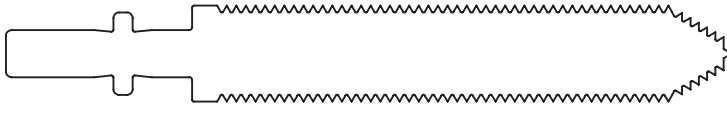
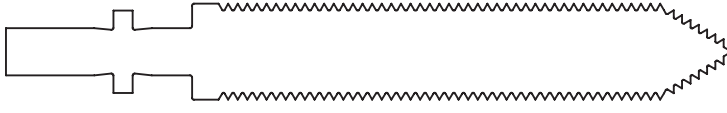
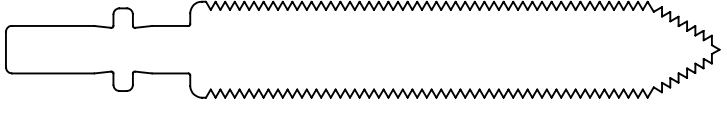

Stryker®					
Order Number	Unit	Length	Width	Material Thickness	Cut Thickness
KM-250R	mm	60	6.3	0.64	1.04
	in	2.36	0.25	0.025	0.041
Replaces Stryker® 277-096-250, 277-96-250					
					Tooth Offset Short Single Sided
KM-275R	mm	70	12.5	0.64	0.94
	in	2.76	0.49	0.025	0.037
Replaces Stryker® 277-096-275, 277-96-275					
					Tooth Offset Double Sided
KM-276R	mm	71.4	12.5	0.79	0.99
	in	2.81	0.49	0.031	0.039
Replaces Stryker® 277-096-276, 277-96-276					
					Tooth Offset Double Sided
KM-277R	mm	70.8	12.5	0.63	1.12
	in	2.79	0.49	0.025	0.044
Replaces Stryker® 277-096-277, 277-96-277					
					Tooth Offset Double Sided
KM-281R	mm	70.0	12.7	1.27	1.40
	in	2.76	0.50	0.050	0.055
Replaces Stryker® 277-096-281					
					Tooth Offset Double Sided

Compatible with Stryker® Reciprocating Saw Systems: 8, 7, 6, 5, 4, 2000, EHD & OrthoPower

STRYKER® |

BUSA® Large Bone Saw Blades Sagittal Stryker® Replacements

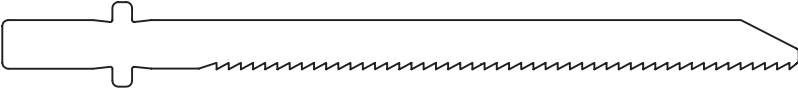
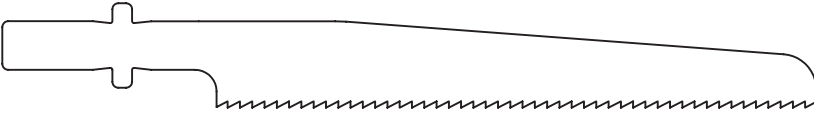
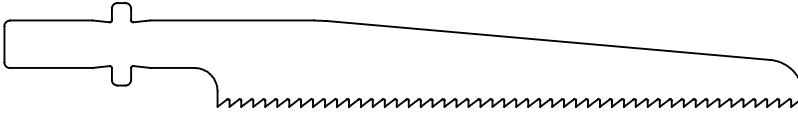
Compatible with Stryker® Reciprocating Saw Systems: 8, 7, 6, 5, 4, 2000, EHD & OrthoPower

Stryker®					
Order Number	Unit	Length	Width	Material Thickness	Cut Thickness
KM-300R	mm	77.5	6.3	0.64	1.04
	in	3.05	0.25	0.025	0.041
Replaces Stryker® 277-096-300, 277-96-300					
					Long Tooth Offset Single Sided
KM-325R	mm	77.5	11.2	0.76	1.17
	in	3.05	0.44	0.030	0.046
Replaces Stryker® 277-096-325, 277-96-325					
					Tooth Offset Single Sided
KM-326R	mm	77.5	11.0	1.24	1.60
	in	3.05	0.43	0.049	0.063
Replaces Stryker® 277-096-326					
					Tooth Offset Single Sided
KM-2279-73	mm	76	12.7	0.90	0.90
	in	2.99	0.50	0.035	0.035
Replaces Stryker® "Replaces N/A - Similar to ConMed® Linvatec® KM-479"					
					No Tooth Offset Double Sided Chromium Coating, Ribbed

STRYKER®

Compatible with Stryker® Reciprocating Saw Systems: 8, 7, 6, 5, 4, 2000, EHD & OrthoPower



BUSA® Large Bone Saw Blades - Sagittal/Oscillating BR2000™ Proprietary - ConMed® Linvatec® K7 Series

Compatible with ConMed® Linvatec® Oscillating Saw Systems:
Hall 50™, MPower®, PowerPro® & VersiPower® Plus

ConMed® Linvatec®

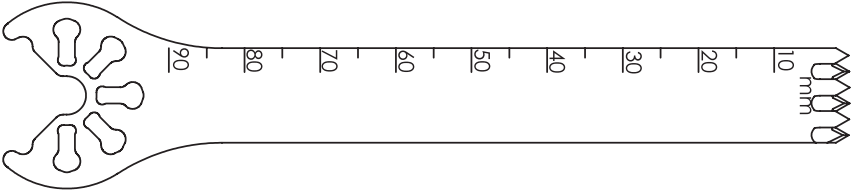
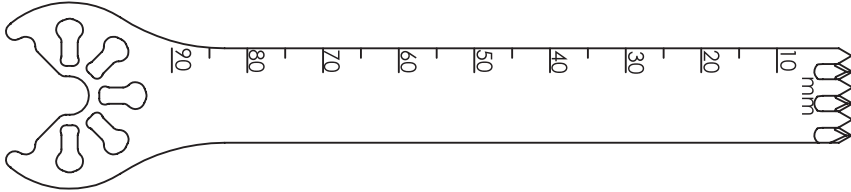
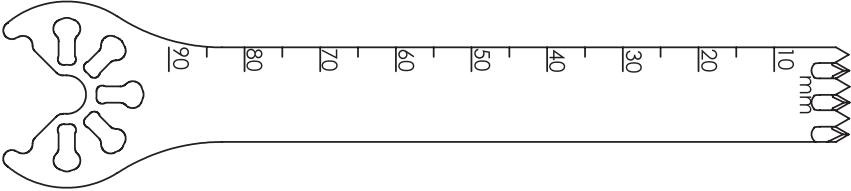
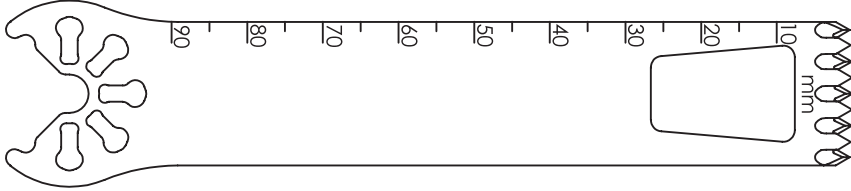
Order Number	Unit	Length	Width	Material Thickness	Cut Thickness
K7-1290-35	mm	90	12.5	0.89	0.89
	in	3.54	0.49	0.035	0.035
Replaces ConMed® Linvatec® 5071-340, T130-089-90, TN130-089-90, V130-089-90					
					
Aggressive Cut No Tooth Offset					
K7-1290-47	mm	90	12.5	1.19	1.19
	in	3.54	0.49	0.047	0.047
Replaces ConMed® Linvatec® 5071-343, T130-119-90, TN130-119-90, V130-119-90					
					
Aggressive Cut No Tooth Offset					
K7-1290-50	mm	90	12.5	1.27	1.27
	in	3.54	0.49	0.050	0.050
Replaces ConMed® Linvatec® 5071-344, T130-127-90, TN130-127-90, V130-127-90					
					
Aggressive Cut No Tooth Offset					
K7-1990-35	mm	90	19	0.89	0.89
	in	3.54	0.75	0.035	0.035
Replaces ConMed® Linvatec® 5071-300, T190-089-90, TN190-089-90, V190-089-90					
					
Aggressive Cut No Tooth Offset					

Compatible with ConMed® Linvatec® Oscillating Saw Systems:
Hall 50™, MPower®, PowerPro® & VersiPower® Plus

CONMED® LINVATEC®

BUSA® Large Bone Saw Blades - Sagittal/Oscillating BR2000™ Proprietary - ConMed® Linvatec® K7 Series



CONMED® LINVATEC®

Compatible with ConMed® Linvatec® Oscillating Saw Systems:
Hall 50™, MPower®, PowerPro® & VersiPower® Plus

**Compatible with ConMed® Linvatec® Oscillating Saw Systems:
Hall 50™, MPower®, PowerPro® & VersiPower® Plus**

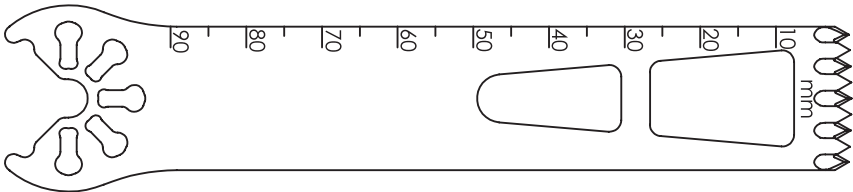
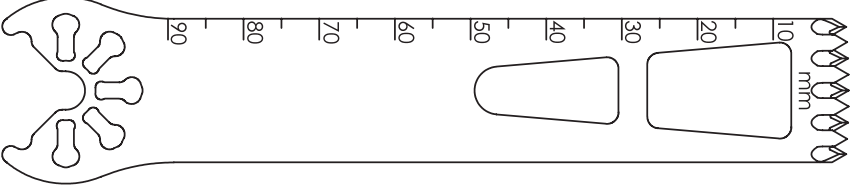
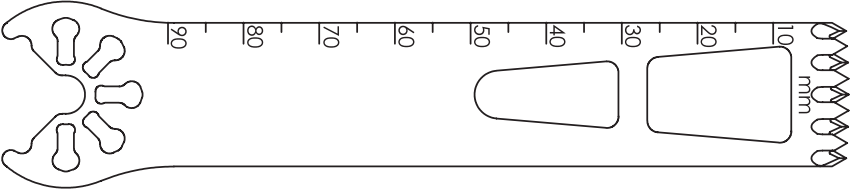
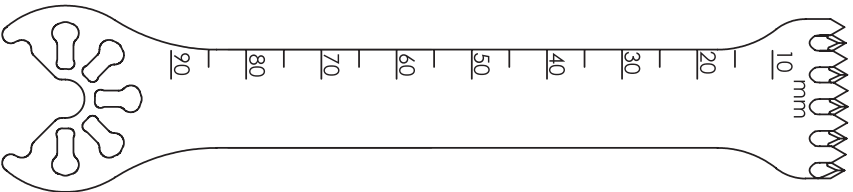
ConMed® Linvatec®					
Order Number	Unit	Length	Width	Material Thickness	Cut Thickness
K7-1990-47	mm	90	19	1.19	1.19
	in	3.54	0.75	0.047	0.047
Replaces ConMed® Linvatec® 5071-303, T190-119-90, TN190-119-90, V190-119-90					
					
Aggressive Cut No Tooth Offset					
K7-1990-50	mm	90	19	1.27	1.27
	in	3.54	0.75	0.050	0.050
Replaces ConMed® Linvatec® 5071-304, T190-127-90, TN190-127-90, V190-127-90					
					
Aggressive Cut No Tooth Offset					
K7-1990-54	mm	90	19	1.37	1.37
	in	3.54	0.75	0.054	0.054
Replaces ConMed® Linvatec® 5071-305, T190-137-90, TN190-137-90, V190-137-90					
					
Aggressive Cut No Tooth Offset					
K7-2190-47F	mm	90	21	1.19	1.19
	in	3.54	0.83	0.047	0.047
Replaces ConMed® Linvatec® 5071-313, T193-119-90, TN193-119-90, V193-119-90					
					
Flared Blade Aggressive Cut No Tooth Offset					



BUSA® Large Bone Saw Blades - Sagittal/Oscillating BR2000™ Proprietary - ConMed® Linvatec® K7 Series

Compatible with ConMed® Linvatec® Oscillating Saw Systems:
Hall 50™, MPower®, PowerPro® & VersiPower® Plus

ConMed® Linvatec®

Order Number	Unit	Length	Width	Material Thickness	Cut Thickness
K7-2590-35	mm	90	25	0.89	0.89
	in	3.54	0.98	0.035	0.035
Replaces ConMed® Linvatec® 5071-320, T250-089-90, TN250-089-90, V250-089-90					
Aggressive Cut No Tooth Offset					
K7-2590-39	mm	90	25	0.99	0.99
	in	3.54	0.98	0.039	0.039
Replaces ConMed® Linvatec® 5071-321, T250-100-90, TN250-100-90, V250-100-90					
Aggressive Cut No Tooth Offset					
K7-2590-47	mm	90	25	1.19	1.19
	in	3.54	0.98	0.047	0.047
Replaces ConMed® Linvatec® 5071-323, T250-119-90, TN250-119-90, V250-119-90					
Aggressive Cut No Tooth Offset					
K7-2590-50	mm	90	25	1.27	1.27
	in	3.54	0.98	0.050	0.050
Replaces ConMed® Linvatec® 5071-324, T250-127-90, TN250-127-90, V250-127-90					
Aggressive Cut No Tooth Offset					

Compatible with ConMed® Linvatec® Oscillating Saw Systems:
Hall 50™, MPower®, PowerPro® & VersiPower® Plus

CONMED® LINVATEC®

BUSA® Large Bone Saw Blades - Sagittal/Oscillating BR2000™ Proprietary - ConMed® Linvatec® K7 Series



Compatible with ConMed® Linvatec® Oscillating Saw Systems:
Hall 50™, MPower®, PowerPro® & VersiPower® Plus

ConMed® Linvatec®

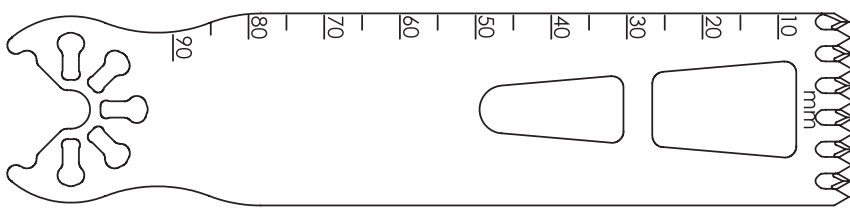
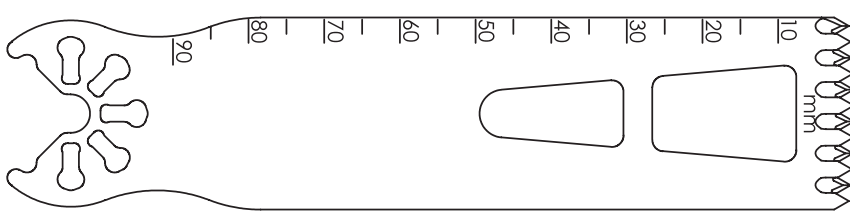
Order Number	Unit	Length	Width	Material Thickness	Cut Thickness
K7-2590-54	mm	90	25	1.37	1.37
	in	3.54	0.98	0.054	0.054
Replaces ConMed® Linvatec® 5071-325, T250-137-90, TN250-137-90, V250-137-90					
					
Aggressive Cut No Tooth Offset					
K7-2590-58	mm	90	25	1.47	1.47
	in	3.54	0.98	0.058	0.058
Replaces ConMed® Linvatec® 5071-326, T250-147-90, TN250-147-90, V250-147-90					
					
Aggressive Cut No Tooth Offset					

CONMED® LINVATEC®

Compatible with ConMed® Linvatec® Oscillating Saw Systems:
Hall 50™, MPower®, PowerPro® & VersiPower® Plus



BUSA® Large Bone Saw Blades - Oscillating ConMed® Linatec® Replacements

Compatible with ConMed® Linatec® Oscillating Saw Systems:
Hall 50™, MPower®, PowerPro® & VersiPower® Plus

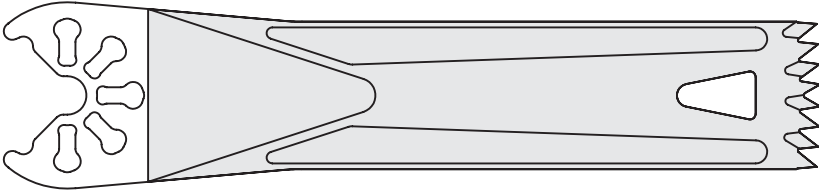
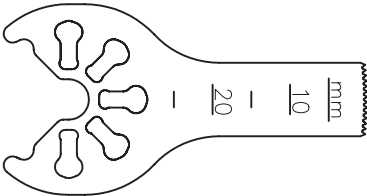
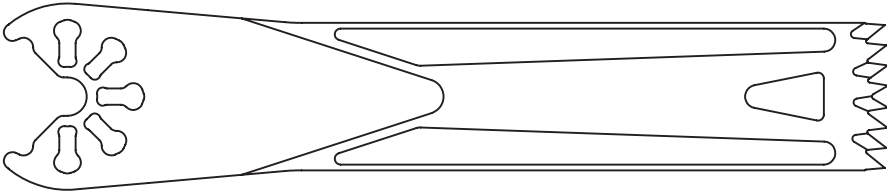
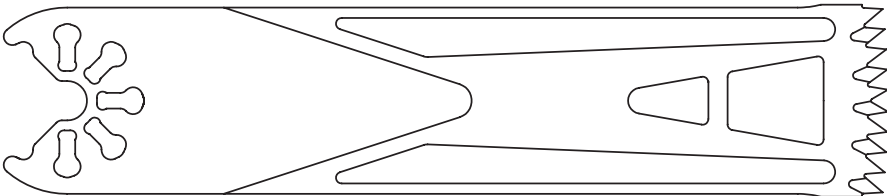
ConMed® Linatec®					
Order Number	Unit	Length	Width	Material Thickness	Cut Thickness
KM71-201	mm	88	19.5	1.27	1.27
	in	3.46	0.77	0.050	0.050
Replaces ConMed® Linatec® 5071-201					
					Opposing Teeth No Tooth Offset Chromium Coating
KM71-233	mm	25	9.5	0.40	0.60
	in	0.98	0.37	0.016	0.024
Replaces ConMed® Linatec® 5071-133, 5071-233					
					Opposing Teeth Tooth Offset ACL Blade
KM71-523	mm	97	19.5	1.27	1.27
	in	3.79	0.77	0.050	0.050
Replaces ConMed® Linatec® 5071-123, 5071-423, 5071-523					
					Opposing Teeth No Tooth Offset
KM71-524	mm	97	25.4	1.27	1.27
	in	3.79	1.00	0.050	0.050
Replaces ConMed® Linatec® 5071-124, 5071-424, 5071-524					
					Opposing Teeth No Tooth Offset

Compatible with ConMed® Linatec® Oscillating Saw Systems:
Hall 50™, MPower®, PowerPro® & VersiPower® Plus

CONMED® LINATEC®

BUSA® Large Bone Saw Blades - Oscillating ConMed® Linatec® Replacements



CONMED® LINATEC®

Compatible with ConMed® Linatec® Oscillating Saw Systems:
Hall 50™, MPower®, PowerPro® & VersiPower® Plus

**Compatible with ConMed® Linatec® Oscillating Saw Systems:
Hall 50™, MPower®, PowerPro® & VersiPower® Plus**

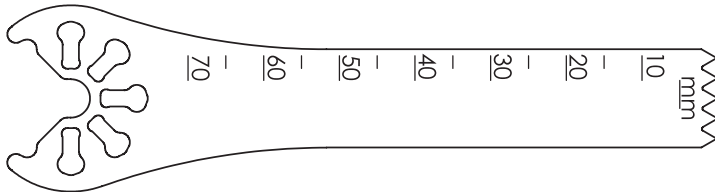
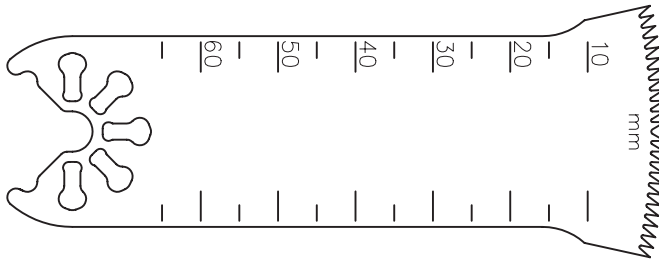
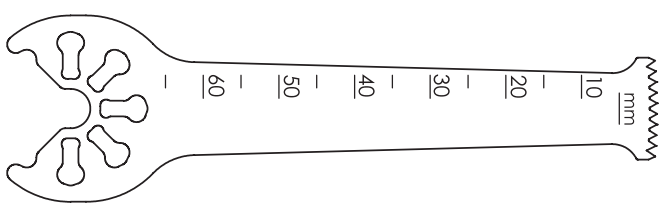
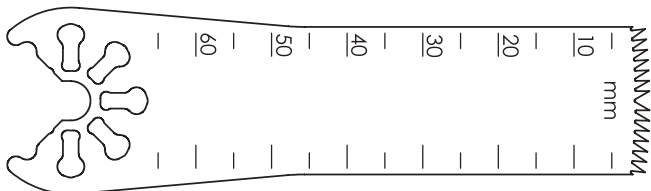
ConMed® Linatec®					
Order Number	Unit	Length	Width	Material Thickness	Cut Thickness
KM71-545	mm	70	13	1.20	1.50
	in	2.76	0.51	0.047	0.059
Replaces ConMed® Linatec® 5071-145, 5071-445, 5071-545					
					
No Opposing Teeth Tooth Offset					
KM71-551	mm	65	32.5	0.61	0.90
	in	2.56	1.28	0.024	0.035
Replaces ConMed® Linatec® 5071-151, 5071-451, 5071-551					
					
Opposing Teeth Tooth Offset Flared Blade					
KM71-552	mm	65	13.5	0.61	0.90
	in	2.56	0.53	0.024	0.035
Replaces ConMed® Linatec® 5071-152, 5071-452, 5071-552					
					
No Opposing Teeth Tooth Offset Flared Blade					
KM71-553	mm	65	19.5	0.61	0.90
	in	2.56	0.77	0.024	0.035
Replaces ConMed® Linatec® 5071-153, 5071-453, 5071-553					
					
Opposing Teeth Tooth Offset					



BUSA® Large Bone Saw Blades - Oscillating ConMed® Linvatec® Replacements

Compatible with ConMed® Linvatec® Oscillating Saw Systems:
Hall 50™, MPower®, PowerPro® & VersiPower® Plus

ConMed® Linvatec®

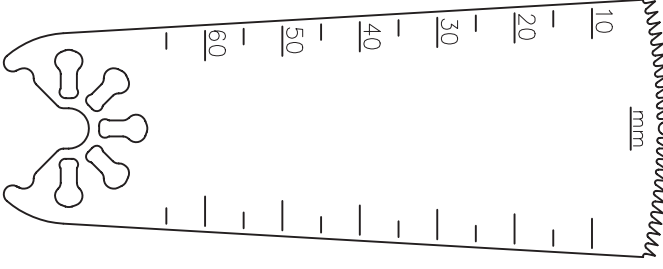
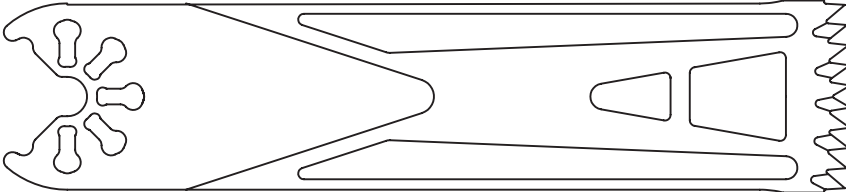
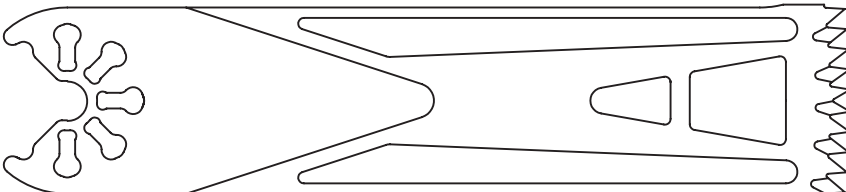
Order Number	Unit	Length	Width	Material Thickness	Cut Thickness
KM71-556	mm	65	33	0.80	0.90
	in	2.56	1.30	0.031	0.035
Replaces ConMed® Linvatec® 5071-156, 5071-456, 5071-556					
					
KM71-561	mm	92	25.4	1.27	1.27
	in	3.62	1.00	0.050	0.050
Replaces ConMed® Linvatec® 5071-161, 5071-461, 5071-561					
					
KM71-563	mm	92	25.4	1.37	1.37
	in	3.62	1.00	0.054	0.054
Replaces ConMed® Linvatec® 5071-163, 5071-463, 5071-563					
					

Compatible with ConMed® Linvatec® Oscillating Saw Systems:
Hall 50™, MPower®, PowerPro® & VersiPower® Plus

CONMED® LINVATEC®

BUSA® Large Bone Saw Blades - Oscillating ConMed® Linvatec® Replacements



CONMED® LINVATEC®

Compatible with ConMed® Linvatec® Oscillating Saw Systems:
Hall 50™, MPower®, PowerPro® & VersiPower® Plus

**Compatible with ConMed® Linvatec® Oscillating Saw Systems:
Hall 50™, MPower®, PowerPro® & VersiPower® Plus**

ConMed® Linvatec®					
Order Number	Unit	Length	Width	Material Thickness	Cut Thickness
KM71-567	mm	92	19.5	1.20	1.20
	in	3.62	0.77	0.047	0.047
Replaces ConMed® Linvatec® 5071-167, 5071-467, 5071-567					
				Chromium Coating Opposing Teeth No Tooth Offset	
KM71-572	mm	70	19.5	0.80	0.90
	in	2.76	0.77	0.031	0.035
Replaces ConMed® Linvatec® 5071-172, 5071-472, 5071-572					
				Opposing Teeth Tooth Offset	
KM71-580	mm	85	10	1.27	1.27
	in	3.35	0.39	0.050	0.050
Replaces ConMed® Linvatec® 5071-180, 5071-480, 5071-580					
				No Opposing Teeth No Tooth Offset Diamond Tooth Design	
KM71-581	mm	88	19.5	1.27	1.27
	in	3.46	0.77	0.050	0.050
Replaces ConMed® Linvatec® 5071-181, 5071-481, 5071-581					
				Opposing Teeth No Tooth Offset	



BUSA® Large Bone Saw Blades - Oscillating ConMed® Linatec® Replacements

**Compatible with ConMed® Linatec® Oscillating Saw Systems:
Hall 50™, MPower®, PowerPro® & VersiPower® Plus**

ConMed® Linatec®

Order Number	Unit	Length	Width	Material Thickness	Cut Thickness
KM71-585	mm	82	19.5	0.90	0.90
	in	3.23	0.77	0.035	0.035

Replaces ConMed® Linatec® 5071-185, 5071-485, 5071-585

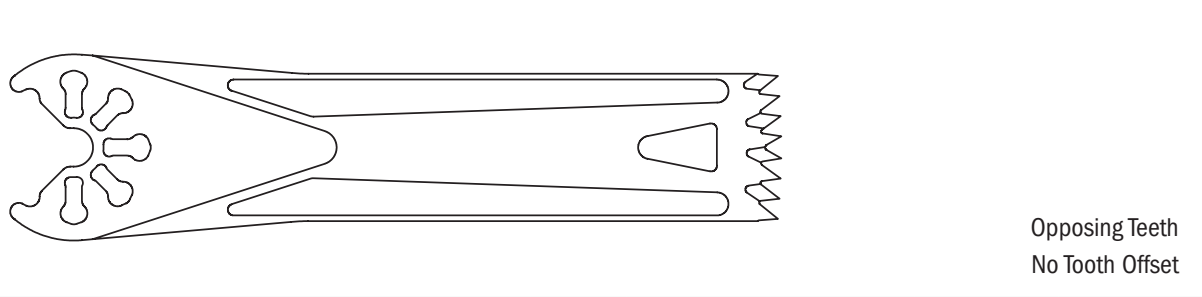

Opposing Teeth
No Tooth Offset

KM71-586	mm	65	32	0.80	0.90
	in	2.56	1.26	0.031	0.035

Replaces ConMed® Linatec® 5071-186, 5071-486, 5071-586

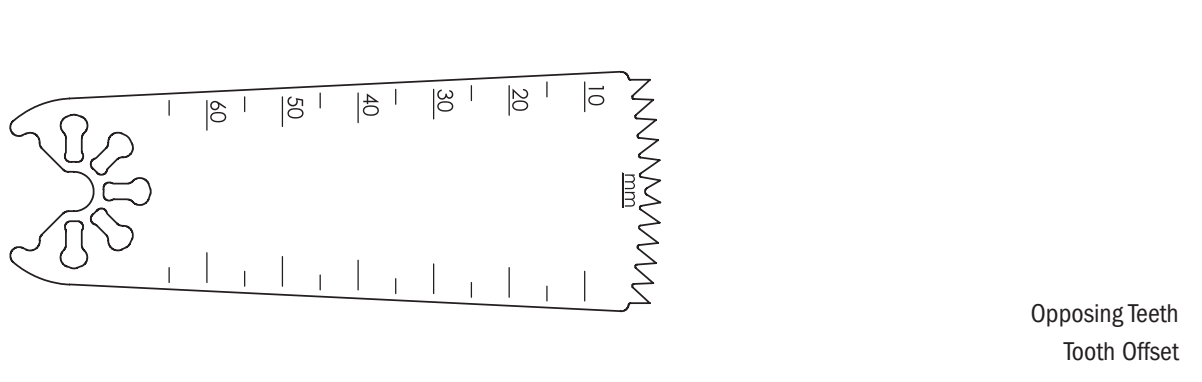

Opposing Teeth
Tooth Offset

Compatible with ConMed® Linatec® Oscillating Saw Systems:
Hall 50™, MPower®, PowerPro® & VersiPower® Plus

CONMED® LINATEC®

BUSA® Large Bone Saw Blades - Oscillating ConMed® Linvatec® Replacements





Compatible with ConMed® Linvatec® Oscillating Saw Systems:
VersiPower®, Series 4, Series 3 & Orthair

ConMed® Linvatec®					
Order Number	Unit	Length	Width	Material Thickness	Cut Thickness
KM-251	mm	60	32.5	0.61	0.90
	in	2.36	1.28	0.024	0.035
Replaces ConMed® Linvatec® 5052-51, 5052-051, 5052-251, 5052-451, 5052-551, Z251					
					Flared Blade Opposing Teeth Tooth Offset
KM-256	mm	60	33.4	0.80	0.90
	in	2.36	1.31	0.031	0.035
Replaces ConMed® Linvatec® "5052-56, 5052056, 5052-256, 5052-456, 5052-556, Z256					
					Opposing Teeth Tooth Offset
KM-451	mm	60	32.5	0.61	0.90
	in	2.36	1.28	0.024	0.035
Replaces ConMed® Linvatec® 5052-51, 5052-051, 5052-251, 5052-451, 5052-551					
					Flared Blade Tooth Offset
KM-453	mm	60	19.5	0.61	0.92
	in	2.36	0.77	0.024	0.036
Replaces ConMed® Linvatec® 5052-53, 5052-053, 5052-153, 5052-253, 5052-453, 5052-553					
					Tooth Offset Opposing Teeth

CONMED® LINVATEC® | Compatible with ConMed® Linvatec® Oscillating Saw Systems:
VersiPower®, Series 4, Series 3 & Orthair

BUSA® Large Bone Saw Blades - Reciprocating Replacements - ConMed® Linvatec®

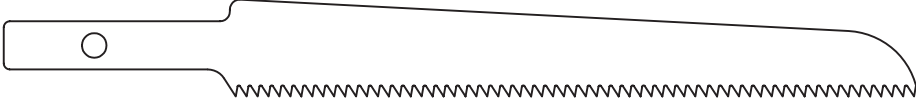
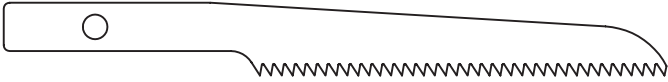
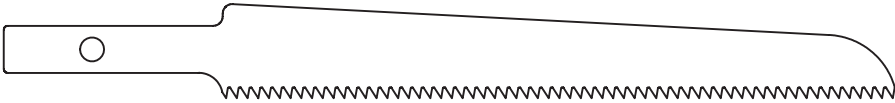
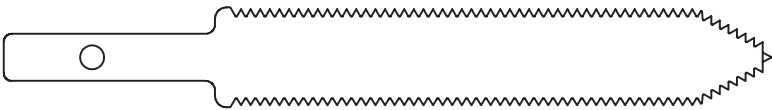
Compatible with ConMed® Linvatec® Reciprocating Saw Systems:
Hall 50™, MPower®, PowerPro®, VersiPower® Plus, VersiPower®, Series 4, Series 3 & Orthair;
MicroAire® & Smith® & Nephew® Large Bone Reciprocating Saw Systems

ConMed® Linvatec®					
Order Number	Unit	Length	Width	Material Thickness	Cut Thickness
KM-458	mm	89	12.5	0.61	1.00
	in	3.50	0.49	0.024	0.039
Replaces ConMed® Linvatec® 5052-58, 5052-058, 5052-158, 5052-258, Z258					
					Tooth Offset
KM-459	mm	54.1	9.4	0.61	1.00
	in	2.13	0.37	0.024	0.039
Replaces ConMed® Linvatec® 5052-59, 5052-059, 5052-159, 5052-259, Z259					
					Tooth Offset
KM-461	mm	89	12.5	1.50	1.60
	in	3.50	0.49	0.059	0.063
Replaces ConMed® Linvatec® 5052-60, 5052-061, 5052-161, 5052-261, Z261					
					Tooth Offset
KM-473	mm	73	12.5	0.80	1.00
	in	2.87	0.49	0.031	0.039
Replaces ConMed® Linvatec® 5052-73, 5052-073, 5052-173, 5052-273, Z273					
					Tooth Offset Double Sided
KM-479	mm	77.5	12.7	0.90	0.90
	in	3.05	0.50	0.035	0.035
Replaces ConMed® Linvatec® 5052-79, 5052-079, 5052-179, 5052-279					
					Chromium Coating No Tooth Offset Double Sided

Compatible with ConMed® Linvatec® Reciprocating Saw Systems:
 Hall 50™, MPower®, PowerPro®, VersiPower® Plus, VersiPower®, Series 4, Series 3 & Orthair;
 MicroAire® & Smith® & Nephew® Large Bone Reciprocating Saw Systems

CONMED® LINVATEC®

BUSA® Large Bone Saw Blades - Sagittal/Oscillating BR2000 - K5 Series - DePuy® Synthes® & Zimmer Biomet®

**Compatible with DePuy® Synthes® Large Bone Oscillating Saw Systems:
Air Power Line, Battery Power Line, Compact Air Drive & Trauma Recon System Sagittal Saw**
Compatible with Zimmer Biomet® Large Bone Oscillating Saw System: Universal

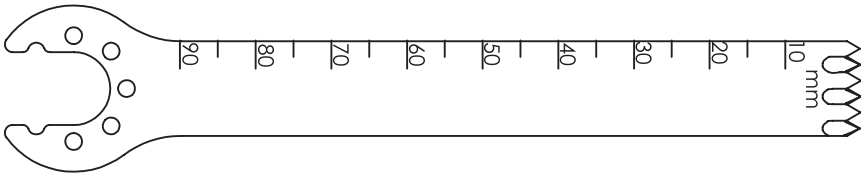
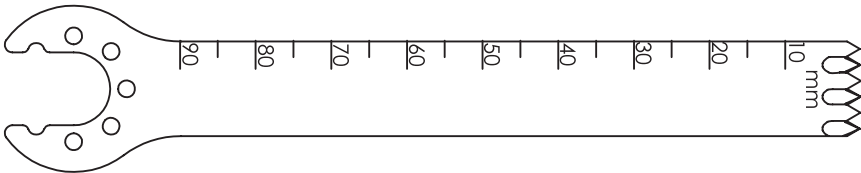
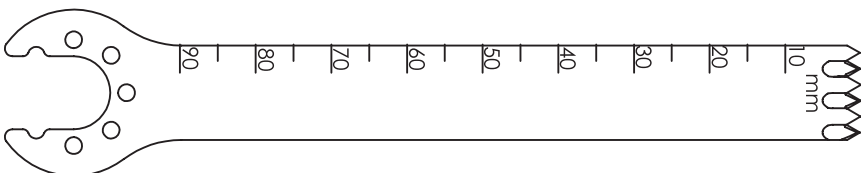
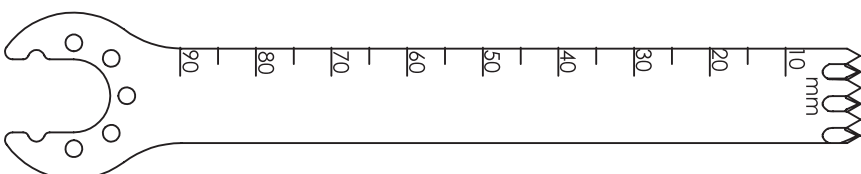
DePuy® Synthes®					
Zimmer® Biomet®					
Order Number	Unit	Length	Width	Material Thickness	Cut Thickness
K5-1290-35	mm	90	12.5	0.89	0.89
	in	3.54	0.49	0.035	0.035
Replaces DePuy® Synthes® 05.002.201S, 05.003.100S					
Replaces Zimmer Biomet® 13-0900-89A-F1					
					Aggressive Cut No Tooth Offset
K5-1290-39	mm	90	12.5	0.99	1.00
	in	3.54	0.49	0.039	0.039
Replaces DePuy® Synthes® 05.002.405S, 05.003.102S					
Replaces Zimmer Biomet® 13-0901-00A-F1					
					Aggressive Cut No Tooth Offset
K5-1290-47	mm	90	12.5	1.19	1.19
	in	3.54	0.49	0.047	0.047
Replaces DePuy® Synthes® 05.002.202S, 05.003.104S					
Replaces Zimmer Biomet® 13-0901-19A-F1					
					Aggressive Cut No Tooth Offset
K5-1290-50	mm	90	12.5	1.27	1.27
	in	3.54	0.49	0.050	0.050
Replaces DePuy® Synthes® 05.002.203S, 05.003.106S					
Replaces Zimmer Biomet® 13-0901-27A-F1					
					Aggressive Cut No Tooth Offset

DEPUY® SYNTHES®
ZIMMER® BIOMET®

Compatible with DePuy® Synthes® Large Bone Oscillating Saw Systems:
Air Power Line, Battery Power Line, Compact Air Drive & Trauma Recon System Sagittal Saw
Compatible with Zimmer Biomet® Large Bone Oscillating Saw System: Universal

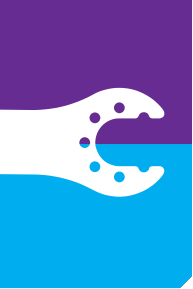

BUSA® Large Bone Saw Blades - Sagittal/Oscillating BR2000 - K5 Series - DePuy® Synthes® & Zimmer Biomet®

Compatible with DePuy® Synthes® Large Bone Oscillating Saw Systems:
Air Power Line, Battery Power Line, Compact Air Drive & Trauma Recon System Sagittal Saw
Compatible with Zimmer Biomet® Large Bone Oscillating Saw System: Universal

Compatible with DePuy® Synthes® Large Bone Oscillating Saw Systems:
 Air Power Line, Battery Power Line, Compact Air Drive & Trauma Recon System Sagittal Saw
 Compatible with Zimmer Biomet® Large Bone Oscillating Saw System: Universal

DEPUY® SYNTHES®
ZIMMER® BIOMET®

DePuy® Synthes®

Zimmer® Biomet®

Order Number	Unit	Length	Width	Material Thickness	Cut Thickness
K5-1290-54	mm	90	12.5	1.37	1.37
	in	3.54	0.49	0.054	0.054

Replaces DePuy® Synthes® 05.002.204S, 05.003.107S

Replaces Zimmer Biomet® 13-0901-37A-F1

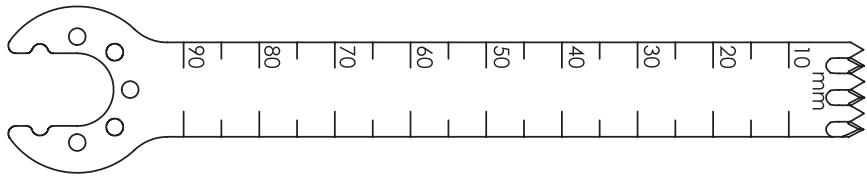

Aggressive Cut
No Tooth Offset

K5-1990-35	mm	90	19	0.89	0.89
	in	3.54	0.75	0.035	0.035

Replaces DePuy® Synthes® 05.002.001S, 05.003.110S

Replaces Zimmer Biomet® 19-0900-89A-F1

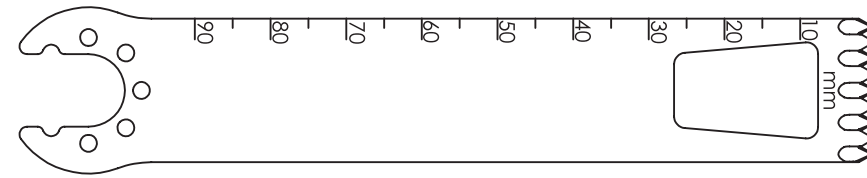

Aggressive Cut
No Tooth Offset

K5-1990-39	mm	90	19	0.99	0.99
	in	3.54	0.75	0.039	0.039

Replaces DePuy® Synthes® 05.002.007S, 05.003.112S

Replaces Zimmer Biomet® 19-0901-00A-F1

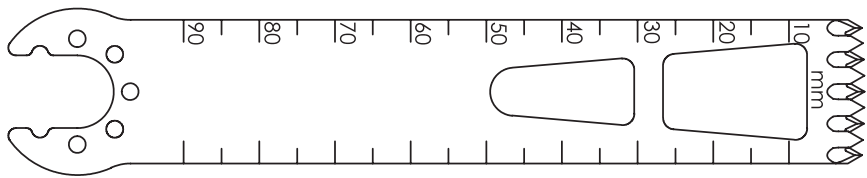

Aggressive Cut
No Tooth Offset

K5-1990-47	mm	90	19	1.19	1.19
	in	3.54	0.75	0.047	0.047

Replaces DePuy® Synthes® 05.002.002S, 05.003.114S

Replaces Zimmer Biomet® 19-0901-19A-G1

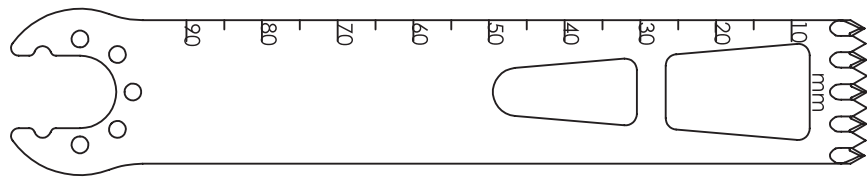

Aggressive Cut
No Tooth Offset

BUSA® Large Bone Saw Blades - Sagittal/Oscillating BR2000 - K5 Series - DePuy® Synthes® & Zimmer Biomet®

Compatible with DePuy® Synthes® Large Bone Oscillating Saw Systems:
Air Power Line, Battery Power Line, Compact Air Drive & Trauma Recon System Sagittal Saw
Compatible with Zimmer Biomet® Large Bone Oscillating Saw System: Universal

DePuy® Synthes®					
Zimmer® Biomet®					
Order Number	Unit	Length	Width	Material Thickness	Cut Thickness
K5-1990-50	mm	90	19	1.27	1.27
	in	3.54	0.75	0.050	0.050
Replaces DePuy® Synthes® 05.002.003S, 05.003.116S					
Replaces Zimmer Biomet® 19-0901-27A-F1, 19-0901-27A-G1					
					Aggressive Cut No Tooth Offset
K5-1990-54	mm	90	19	1.37	1.37
	in	3.54	0.75	0.054	0.054
Replaces DePuy® Synthes® 05.002.004S, 05.003.117S					
Replaces Zimmer Biomet® 19-0901-37A-G1					
					Aggressive Cut No Tooth Offset
K5-2190-47F	mm	90	21	1.19	1.19
	in	3.54	0.83	0.047	0.047
Replaces DePuy® Synthes® 05.002.302S, 05.003.124S					
Replaces Zimmer Biomet® 21-0901-19A-V1					
					Flared Blade Aggressive Cut No Tooth Offset
K5-2190-50F	mm	90	21	1.27	1.27
	in	3.54	0.83	0.050	0.050
Replaces DePuy® Synthes® 05.002.303S, 05.003.126S					
Replaces Zimmer Biomet® 21-0901-27A-V1					
					Flared Blade Aggressive Cut No Tooth Offset

DEPUY® SYNTHES®
ZIMMER® BIOMET®

Compatible with DePuy® Synthes® Large Bone Oscillating Saw Systems:
Air Power Line, Battery Power Line, Compact Air Drive & Trauma Recon System Sagittal Saw
Compatible with Zimmer Biomet® Large Bone Oscillating Saw System: Universal

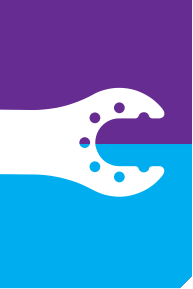

BUSA® Large Bone Saw Blades - Sagittal/Oscillating BR2000 - K5 Series - DePuy® Synthes® & Zimmer Biomet®

Compatible with DePuy® Synthes® Large Bone Oscillating Saw Systems:
Air Power Line, Battery Power Line, Compact Air Drive & Trauma Recon System Sagittal Saw
Compatible with Zimmer Biomet® Large Bone Oscillating Saw System: Universal

Compatible with DePuy® Synthes® Large Bone Oscillating Saw Systems:
 Air Power Line, Battery Power Line, Compact Air Drive & Trauma Recon System Sagittal Saw
 Compatible with Zimmer Biomet® Large Bone Oscillating Saw System: Universal

DEPUY® SYNTHES®
ZIMMER® BIOMET®

DePuy® Synthes® Zimmer® Biomet®

Order Number	Unit	Length	Width	Material Thickness	Cut Thickness
K5-2190-54F	mm	90	21	1.37	1.37
	in	3.54	0.83	0.054	0.054

Replaces DePuy® Synthes® 05.002.304S, 05.003.127S

Replaces Zimmer Biomet® 21-0901-37A-V1

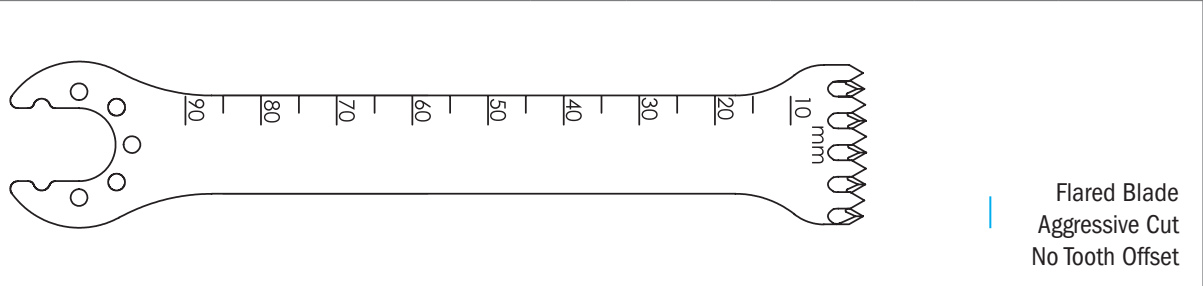

K5-2590-35	mm	90	25	0.89	0.89
	in	3.54	0.98	0.035	0.035

Replaces DePuy® Synthes® 05.002.101S, 05.003.130S

Replaces Zimmer Biomet® 25-0900-89A-F1

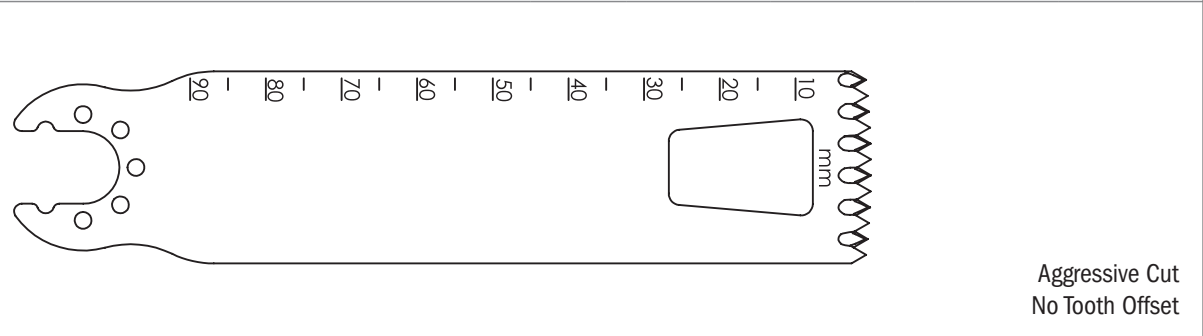

K5-2590-39	mm	90	25	0.99	0.99
	in	3.54	0.98	0.039	0.039

Replaces DePuy® Synthes® 05.002.106S, 05.003.132S

Replaces Zimmer Biomet® 25-0901-00A-F1

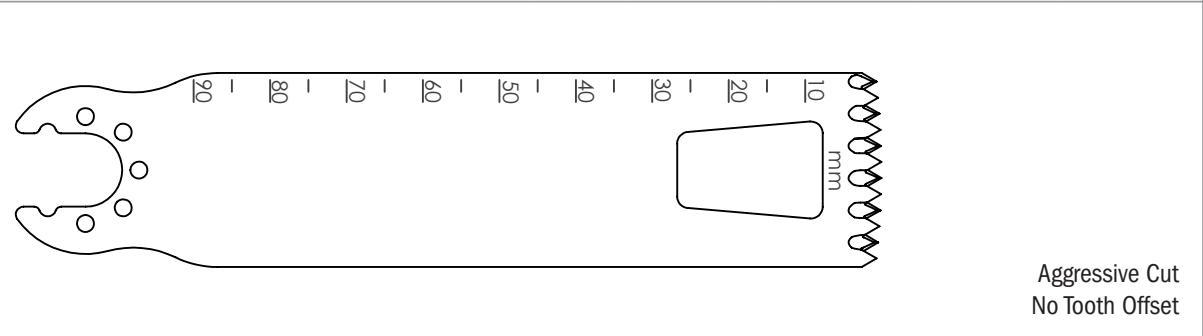

BUSA® Large Bone Saw Blades - Sagittal/Oscillating BR2000 - K5 Series - DePuy® Synthes® & Zimmer Biomet®

**Compatible with DePuy® Synthes® Large Bone Oscillating Saw Systems:
Air Power Line, Battery Power Line, Compact Air Drive & Trauma Recon System Sagittal Saw**
Compatible with Zimmer Biomet® Large Bone Oscillating Saw System: Universal

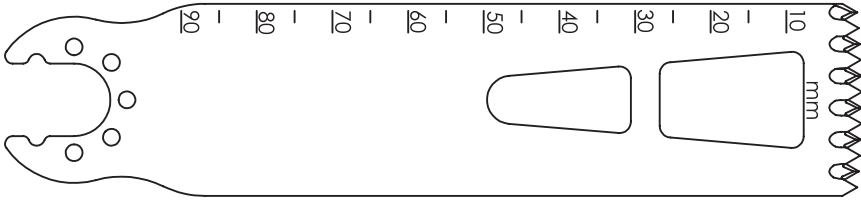
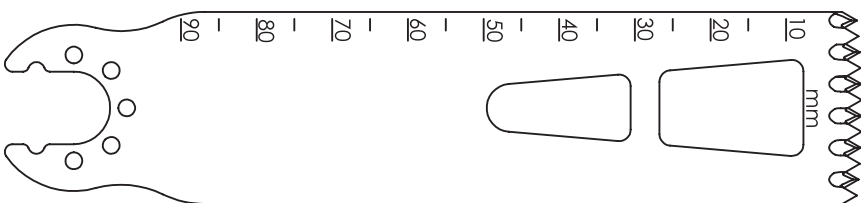
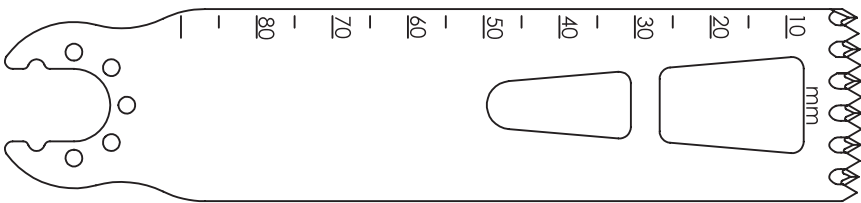
DePuy® Synthes®					
Zimmer® Biomet®					
Order Number	Unit	Length	Width	Material Thickness	Cut Thickness
K5-2590-47	mm	90	25	1.19	1.19
	in	3.54	0.98	0.047	0.047
Replaces DePuy® Synthes® 05.002.102S, 05.003.134S					
Replaces Zimmer Biomet® 25-0901-19A-B1, 25-0901-19A-F1, 25-0901-19A-G1					
					Aggressive Cut No Tooth Offset
K5-2590-50	mm	90	25	1.27	1.19
	in	3.54	0.98	0.050	0.047
Replaces DePuy® Synthes® 05.002.102S, 05.003.134S					
Replaces Zimmer Biomet® 25-0901-19A-B1, 25-0901-19A-F1, 25-0901-19A-G1					
					Aggressive Cut No Tooth Offset
K5-2590-58	mm	90	25	1.47	1.47
	in	3.54	0.98	0.058	0.058
Replaces DePuy® Synthes® 05.002.105S, 05.003.139S					
Replaces Zimmer Biomet® 25-0901-47A-B1					
					Aggressive Cut No Tooth Offset

DEPUY® SYNTHES®
ZIMMER® BIOMET®

Compatible with DePuy® Synthes® Large Bone Oscillating Saw Systems:
Air Power Line, Battery Power Line, Compact Air Drive & Trauma Recon System Sagittal Saw
Compatible with Zimmer Biomet® Large Bone Oscillating Saw System: Universal

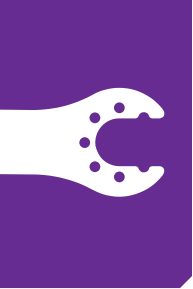

BUSA® Large Bone Saw Blades - Oscillating DePuy® Synthes® Replacements

Compatible with DePuy® Synthes® Large Bone Oscillating Saw Systems:
Air Power Line, Battery Power Line, Compact Air Drive & Trauma Recon System Sagittal Saw
Compatible with Zimmer Biomet® Large Bone Oscillating Saw System: Universal

DePuy® Synthes®

Order Number	Unit	Length	Width	Material Thickness	Cut Thickness
KM519-10	mm	50.0	27	0.40	0.66
	in	1.97	1.06	0.016	0.026

Replaces DePuy® Synthes® 519.10, 519.100S

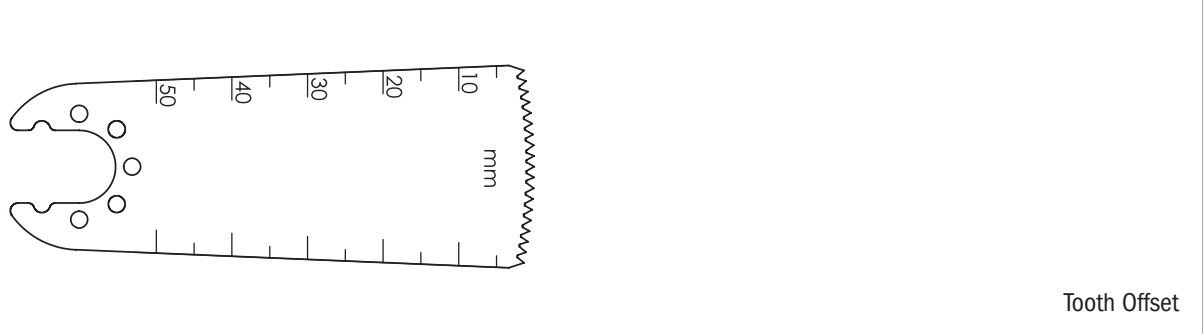

KM519-15	mm	50.0	14	0.40	0.66
	in	1.97	0.55	0.016	0.026

Replaces DePuy® Synthes® 519.15, 519.150S

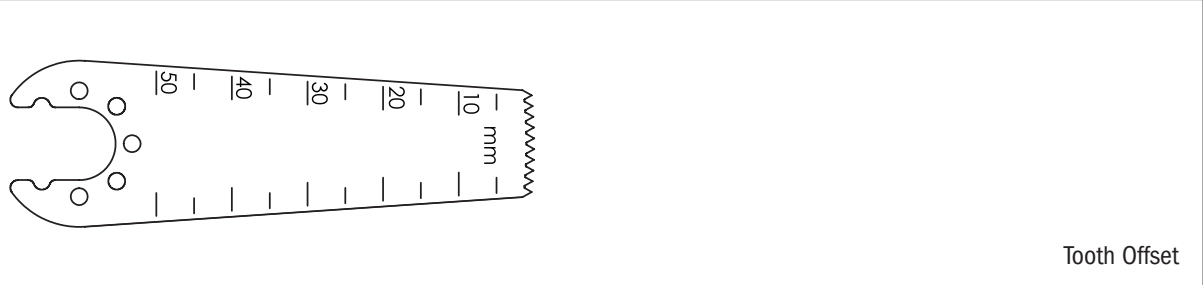

KM519-17	mm	70	27	0.64	0.81
	in	2.76	1.06	0.025	0.032

Replaces DePuy® Synthes® 519.17, 519.170S

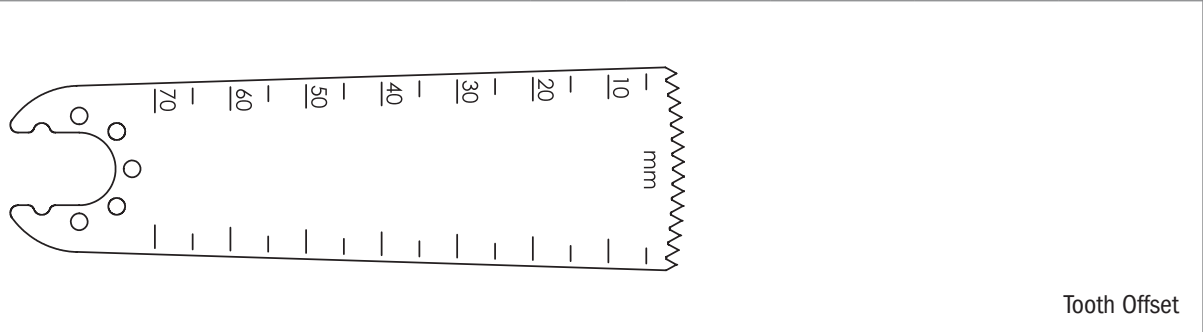

Compatible with DePuy® Synthes® Large Bone Oscillating Saw Systems:
 Air Power Line, Battery Power Line, Compact Air Drive & Trauma Recon System Sagittal Saw
 Compatible with Zimmer Biomet® Large Bone Oscillating Saw System: Universal

BUSA® Large Bone Saw Blades - Oscillating DePuy® Synthes® Replacements

Compatible with DePuy® Synthes® Large Bone Oscillating Saw Systems:
Air Power Line, Battery Power Line, Compact Air Drive & Trauma Recon System Sagittal Saw
Compatible with Zimmer Biomet® Large Bone Oscillating Saw System: Universal

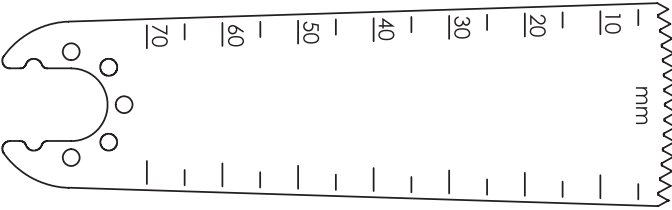
DePuy® Synthes®					
Order Number	Unit	Length	Width	Material Thickness	Cut Thickness
KM519-21	mm	70	27	0.99	1.19
	in	2.76	1.06	0.039	0.047
Replaces DePuy® Synthes® 519.21, 519.210S					
					
					Tooth Offset

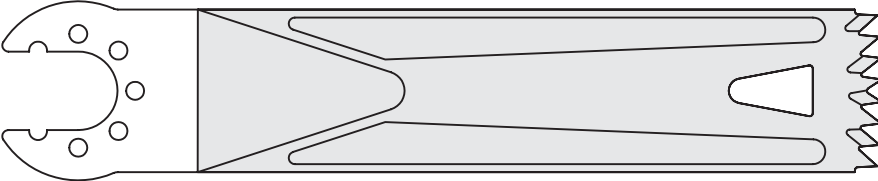
KM-1201-84	mm	86	19.5	1.27	1.27
	in	3.39	0.77	0.050	0.050
Replaces DePuy® Synthes® N/A (Similar to ConMed® Linvatec® 5071-201)					
					
					Special No Tooth Offset Opposing Teeth Chromium Coating

DEPUY® SYNTHES®





Compatible with DePuy® Synthes® Large Bone Oscillating Saw Systems:
 Air Power Line, Battery Power Line, Compact Air Drive & Trauma Recon System Sagittal Saw
 Compatible with Zimmer Biomet® Large Bone Oscillating Saw System: Universal

BUSA® Large Bone Saw Blades - Reciprocating DePuy® Synthes® Replacements

Compatible with DePuy® Synthes® Large Bone Reciprocating Saw Systems:
Air Power Line, Battery Power Line, Compact Air Drive & Trauma Recon System (TRS) Sagittal Saw

Compatible with DePuy® Synthes® Large Bone Reciprocating Saw Systems:
Air Power Line, Battery Power Line, Compact Air Drive & Trauma Recon System (TRS) Sagittal Saw

DEPUY® SYNTHES®

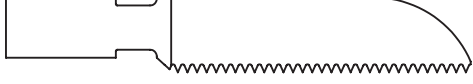
DePuy® Synthes®					
Order Number	Unit	Length	Width	Material Thickness	Cut Thickness
BR511-905S	mm	80	10	1.19	1.05
	in	3.15	0.39	0.047	0.041
Replaces DePuy® Synthes® 511.905S					
					Tooth Offset Single-Sided
BR511-907S	mm	55	10	1.19	1.05
	in	2.17	0.39	0.047	0.041
Replaces DePuy® Synthes® 511.907S					
					Tooth Offset Single-Sided
BR511-909S	mm	55	10	1.19	0.85
	in	2.17	0.39	0.047	0.033
Replaces DePuy® Synthes® 511.909S					
					Tooth Offset Single-Sided
BR511-912S	mm	68	12	1.19	1.09
	in	2.68	0.47	0.047	0.043
Replaces DePuy® Synthes® 511.912S					
					Tooth Offset Single-Sided
BR511-915S	mm	40	10	1.19	1.10
	in	1.57	0.39	0.047	0.043
Replaces DePuy® Synthes® 511-915S					
					Tooth Offset Single-Sided

BUSA® Large Bone Saw Blade - Reciprocating

Zimmer Biomet® Replacements

Compatible with Zimmer Biomet® Reciprocating Saw System: Universal

Zimmer® Biomet®					
Order Number	Unit	Length	Width	Material Thickness	Cut Thickness
ZB12-0761-00U-R1	mm	70	12.5	0.61	0.90
	in	2.76	0.49	0.024	0.035
Replaces Zimmer Biomet® 12-0761-00U-R1					
					Tooth Offset Double-Sided Sterile

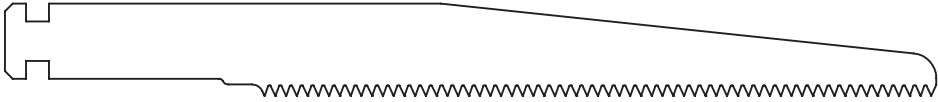
ZB12-0901-19U-R1	89.4	12.2	0.90	1.14	1.27
	3.52	0.48	0.035	0.045	0.050
Replaces Zimmer Biomet® 12-0901-19U-R1					
					Special Tooth Offset Single-Sided Sterile

ZIMMER® BIOMET®

Compatible with Zimmer Biomet® Reciprocating Saw System: Universal